



Diffused Lens Strip (SDL)

Indoor Industrial LED Strip Light



OVERVIEW

Lumen Package (lm)	1,500 - 18,000
CCT (K)	3000K, 3500K, 4000K, 5000K
Wattage Range (W)	132 - 149
Efficacy Range (LPW)	12 - 142
Weight lbs (kg)	2ft - 3, 4ft - 9, 8ft - 18

QUICK LINKS

FEATURES & SPECIFICATIONS

Construction

- Rigid housing is die-formed 22-gauge cold rolled steel
- Mount individually or in continuous rows with optional plug assembly kits
- Tool-less wireway access with removable lens and light engine
- Luminaire is painted after fabrication following treatment with phosphate rust inhibitor. Finish coat of housing is high reflectance white (minimum 92%) polyester powder.

Optical System

- High transmission custom extruded frosted acrylic radius lens eliminates bright spots from individual LED's and provides high vertical illumination and visual comfort.
- Minimum CRI of 80.

Electrical

- High-performance driver features overvoltage, under-voltage, short-circuit and over temperature protection.
- 0-10V dimming (10% - 100%) standard.
- Standard Universal Voltage (120-277 VAC) Input 50/60 Hz or optional 347.

- L70 Calculated Life: >60K hours.
- Total harmonic distortion: <20%.
- Operating temperature: -30°C to +50°C (-22°F to +122°F).
- Power factor: >.90.
- Optional 120-277V 10W integral emergency battery backup is available to meet critical life-safety lighting requirements. A test switch/indicator button will be installed on the housing.

Controls

- Optional external passive infrared motion and photocell sensor.
- Optional step-level dimming driver allows system to be switched to 50% power.

Installation

- Surface mounting is standard. Chain, pendant, and grid mounting options available with accessories.
- Accepts optional plug-in wiring feature for continuous row installation.

Warranty

- LSI luminaires carry a 5-year limited warranty. Refer to <https://www.lsicorp.com/resources/terms-conditions-warranty/> for more information.

Listings

- Listed to UL 1598 and UL 8750.
- Suitable for damp locations
- Meets Buy American Act requirements.
- Title 24 Compliant; see local ordinance for qualification information.
- DesignLights Consortium® (DLC) Premium qualified product. Not all versions of this product may be DLC Premium qualified. Please check the DLC Qualified Products List at www.designlights.org/QPL to confirm which versions are qualified.

Diffused Lens Strip (SDL)

Type : _____

 **Have questions?** Call us at (800) 436-7800

ORDERING GUIDE

TYPICAL ORDER EXAMPLE: SDL4 LED 40L FL UNV DIM1 40 80CRI									
Prefix	Light Source	Lumen Package	Lens	Voltage	Driver	Color Temperature	CRI	Controls	Options
SDL2 - 2' Strip SDL4 - 4' Strip SDL8 - 8' Strip	LED	15L - 1500 Lumens ¹ 20L - 2000 Lumens ² 30L - 3000 Lumens ² 40L - 4000 Lumens ³ 50L - 5000 Lumens ³ 60L - 6000 Lumens ³ 70L - 7000 Lumens ⁷ 80L - 8000 Lumens ⁷ 100L - 10000 Lumens ⁴ 120L - 12000 Lumens ⁴ 140L - 14000 Lumens ⁴ 160L - 16000 Lumens ⁴ 180L - 18000 Lumens ⁴ Custom Lumen ⁵	FL - Frosted Lens	UNV - 120-277V 347 - 347V	DIM1 - Dims to 1% (0-10V)	30 - 3000K 35 - 3500K 40 - 4000K 50 - 5000K	80CRI - 80 CRI	Standard - None OCSE - Occupancy Sensor (120-277V) ⁶ ALBC - Airlink Blue Controller ALBCSD - Airlink Blue Controller & Daylight Harvesting/Occupancy Sensor (120-277V) ⁷	Standard - None EM10 - 10W Battery Backup ⁶ PM1 - 9ft Pre-wired plug assembly for row mounting (Standard) ⁶ PM1LV - 9ft Pre-wired plug assembly for row mounting (0-10V Dimming) ⁶ PM2 - 9ft Pre-wired plug assembly for row mounting (SD50 or EM10) ⁶ PM2LV - 9ft Pre-wired plug assembly for row mounting (SD50 or EM10 with 0-10V Dimming) ⁶



Need more information?
Click here for our glossary

Have additional questions?
Call us at (800) 436-7800



ACCESSORY ORDERING INFORMATION

Catalog Number	Description	Order Number
GRD HGR	T-Grid Hanger Kit (Qty 2)	671560
TBKT	T-Grid Collar (Qty 1)	558651
CHS 3FT	Chain Hanger Set (36" length) (Qty 2)	M38258
CHS 5FT	Chain Hanger Set (60" length) (Qty 2)	251057
TCH10	10ft Toggle Cable Assembly 2pk	431373
PMK24	24" Pendant Kit (Qty 1)	687400
PMK36	36" Pendant Kit (Qty 1)	681509
PMK48	48" Pendant Kit (Qty 1)	687382
WG SDL/S	Wire Guard 4ft	762864

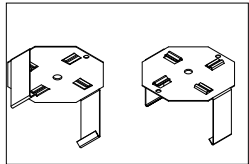

Description: T-Grid Hanger Kit
Order Number: (Qty 2) - 671560

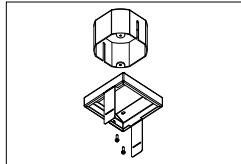

Description: T-Grid Collar (including junction box, wire collar & grid hanger)
Order Number: (Qty 1) - 558651

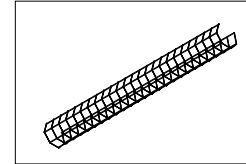

Description: Wire Guard - 4 foot
Order Number: (Qty 1) - 762864

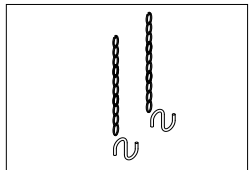

Description: Chain Hanger Set (36" length)
Order Number: (Qty 2) - M38258

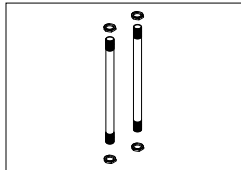

Description: 24" Pendant
Order Number: (Qty 1) - 687400

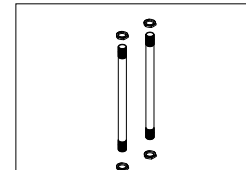

Description: 48" Pendant
Order Number: (Qty 1) - 687382

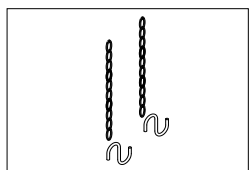

Description: Chain Hanger Set (60" length)
Order Number: (Qty 2) - 251057

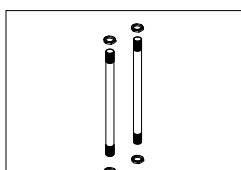

Description: 36" Pendant
Order Number: (Qty 1) - 681509

1 - Available in 2ft only
2 - Available in 2ft, 4ft only
3 - Available in 4ft only
4 - Available in 8ft only

5 - Custom lumen and wattages available, consult factory. Values are within industry standard tolerances and not DLC listed.
6 - Not available with 347V
7 - Available in 4ft and 8ft only

Diffused Lens Strip (SDL)

Type : _____

 Have questions? Call us at (800) 436-7800

PERFORMANCE

Delivered Lumens											
Length	Lumen Package	CRI	3000K CCT		3500K CCT		4000K CCT		5000K CCT		Wattage
			Delivered Lumens	Efficacy	Delivered Lumens	Efficacy	Delivered Lumens	Efficacy	Delivered Lumens	Efficacy	
2'	15L	80	1516	120	1574	124	1552	124	1659	132	13
	20L		2034	126	2112	130	2082	129	2226	133	16
	30L		2964	122	3077	126	3034	124	3243	133	24
4'	20L	80	1947	120	2015	133	2009	132	2148	140	15
	30L		2930	126	3041	135	3032	134	3242	143	23
	40L		3879	129	4026	134	4014	133	4292	143	30
	50L		4833	126	5017	131	5002	130	5348	139	38
	60L		5815	133	6036	138	6018	137	6434	147	44
	70L		6788	130	7046	135	7025	135	7511	144	52
	80L		7776	127	8072	132	8048	131	8605	141	61
8'	70L	80	6885	131	7137	136	7018	134	7530	143	52
	80L		7922	131	8212	136	8075	133	8664	143	61
	100L		9809	135	10168	140	9998	137	10727	147	73
	120L		11833	132	12267	137	12062	134	12942	144	90
	140L		13779	130	14283	135	14045	132	15070	142	106
	160L		15743	127	16319	132	16047	129	17218	139	124
	180L		17678	124	18325	129	18019	127	19334	136	142

*LED chips are frequently updated therefore values are subject to change.

Electrical Data*					
Length	Lumens	120V	208V	240V	277V
2'	15L	0.11A	0.06A	0.05A	0.05A
	20L	0.14A	0.08A	0.07A	0.06A
	30L	0.20A	0.12A	0.10A	0.09A
4'	20L	0.13A	0.07A	0.06A	0.05A
	30L	0.19A	0.11A	0.09A	0.08A
	40L	0.25A	0.14A	0.13A	0.11A
	50L	0.32A	0.18A	0.16A	0.14A
	60L	0.37A	0.21A	0.18A	0.16A
	70L	0.44A	0.25A	0.22A	0.19A
	80L	0.51A	0.29A	0.26A	0.22A
8'	70L	0.44A	0.25A	0.22A	0.19A
	80L	0.51A	0.29A	0.25A	0.22A
	100L	0.61A	0.35A	0.30A	0.26A
	120L	0.75A	0.43A	0.37A	0.32A
	140L	0.89A	0.51A	0.44A	0.38A
	160L	1.03A	0.59A	0.52A	0.45A
	180L	1.19A	0.68A	0.59A	0.51A

*Electrical data at 25C (77F). Actual wattage may differ by +/-10%.

Recommended Lumen Maintenance ¹							
Length	Lumens	Ambient Temp	0 hrs. ²	25K hrs. ²	50K hrs. ²	75K hrs. ³	100K hrs. ²
2'	30L	25C	98%	96%	94%	93%	91%
	40L	25C	99%	97%	95%	94%	92%
4'	80L	25C	98%	96%	93%	91%	89%
	80L	25C	98%	96%	95%	93%	91%
8'	180L	25C	97%	91%	85%	80%	75%

1 - Lumen maintenance values at 25°C are calculated per TM-21 based on LM-80 data and in-situ luminaire testing.

2 - In accordance with IESNA TM-21-11, Projected Values represent interpolated value based on time durations that are within six times (6X) the IESNA LM-80-08 total test duration (in hours) for the device under testing (DUT) i.e. the packaged LED chip.

3 - In accordance with IESNA TM-21-11, Calculated Values represent time durations that exceed six times NA LM-80-08 total test duration (in hours) for the device under testing (DUT) i.e. the packaged LED chip.

Diffused Lens Strip (SDL)

Type : _____

 Have questions? Call us at (800) 436-7800

PHOTOMETRICS

Luminaire photometry has been conducted by a NVLAP accredited testing laboratory in accordance with IESNA LM-79-08. As specified by IESNA LM-79-08 the entire luminaire is tested as the source resulting in a luminaire efficiency of 100%.

See the individual product page on <https://www.lsicorp.com/> for detailed photometric data.

SDL2 20L 40

Luminaire Data	
Symmetric Distribution	
Description	4000 Kelvin, 80 CRI
Delivered Lumens	2,082
Watts	16
Efficacy	129

Zonal Lumen Summary		
Zone	Lumens	%Luminaire
Low (0-30)°	411	20%
Medium (30-60)°	860	41%
High (60-80)°	445	21%
Very High (80-90)°	138	7%
Uplight (90-180)°	226	11%
Total Flux	2082	100%

Polar Curve

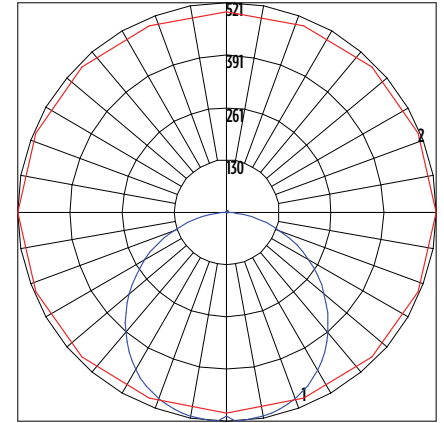

 Vertical Plane  Horizontal Cone



SDL4 40L 40

Luminaire Data	
Symmetric Distribution	
Description	4000 Kelvin, 80 CRI
Delivered Lumens	4,014
Watts	30
Efficacy	134

Zonal Lumen Summary		
Zone	Lumens	%Luminaire
Low (0-30)°	794	20%
Medium (30-60)°	1662	41%
High (60-80)°	859	21%
Very High (80-90)°	265	7%
Uplight (90-180)°	431	11%
Total Flux	4014	100%

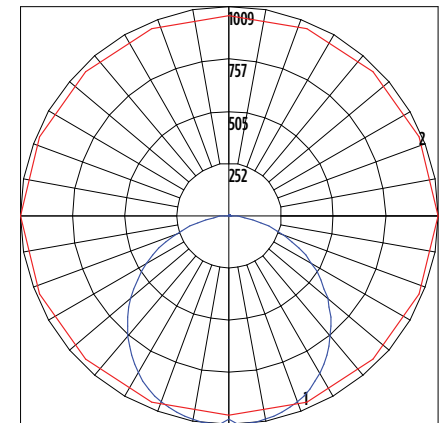
Polar Curve



 Vertical Plane  Horizontal Cone

SDL8 80L 40

Luminaire Data	
Symmetric Distribution	
Description	4000 Kelvin, 80 CRI
Delivered Lumens	8,075
Watts	61
Efficacy	133

Zonal Lumen Summary		
Zone	Lumens	%Luminaire
Low (0-30)°	1593	20%
Medium (30-60)°	3333	41%
High (60-80)°	1722	21%
Very High (80-90)°	533	7%
Uplight (90-180)°	864	11%
Total Flux	8075	100%

Polar Curve

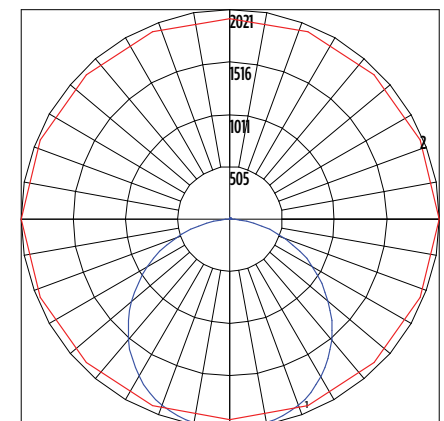

 Vertical Plane  Horizontal Cone

Diffused Lens Strip (SDL)

Type : _____

 Have questions? Call us at (800) 436-7800

PRODUCT DIMENSIONS

S2

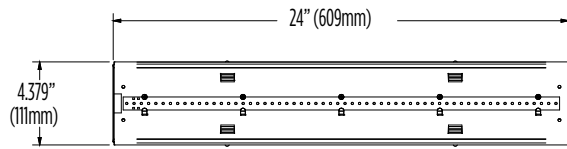

TOP VIEW

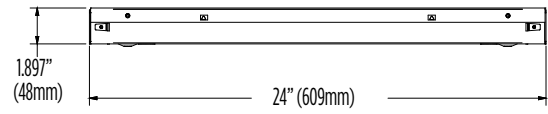

SIDE VIEW

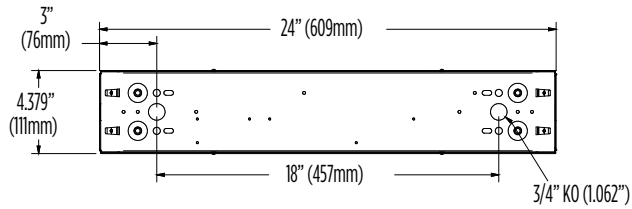

BOTTOM VIEW

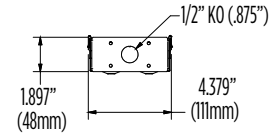

END VIEW

S4

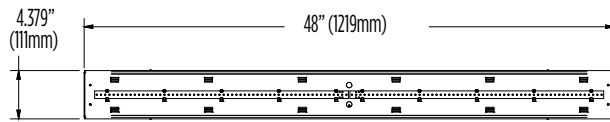

TOP VIEW

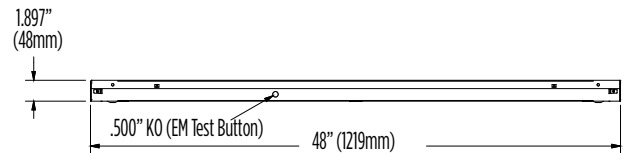

SIDE VIEW

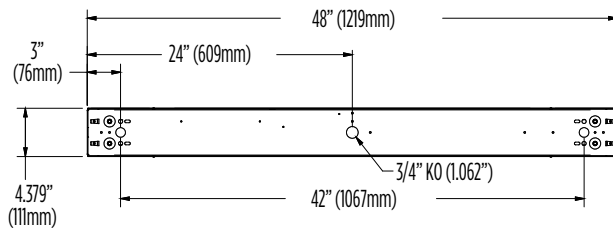

BOTTOM VIEW

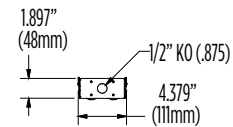

END VIEW

S8

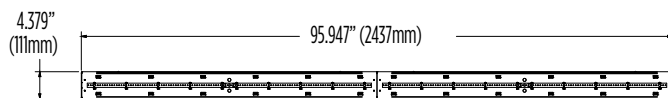

TOP VIEW

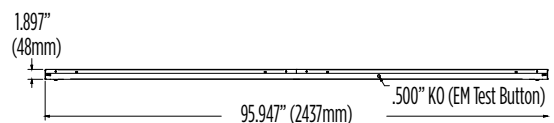

SIDE VIEW

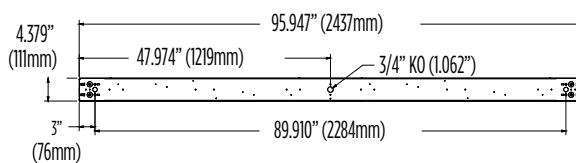

BOTTOM VIEW

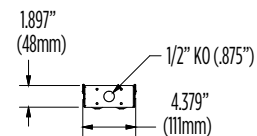

END VIEW