



# Mirada Large (MRL)

## Outdoor LED Area Light



OVERVIEW	
Lumen Package	40,000 - 78,000
Wattage Range	286 - 648
Efficacy Range (LPW)	115 - 154
Weight lbs(kg)	60 (27.2)
Control Options	IMSBT, ALB, ALS, 7-Pin

### QUICK LINKS

- [Ordering Guide](#)
- [Performance](#)
- [Photometrics](#)
- [Dimensions](#)

## FEATURES & SPECIFICATIONS

### Construction

- Rugged die-cast aluminum housing, optical frame, and driver access cover.
- Fixtures are finished with LSI's DuraGrip<sup>®</sup> polyester powder coat finishing process. The DuraGrip finish withstands extreme weather changes without cracking or peeling. Other standard LSI finishes available. Consult factory.
- Shipping weight: 68 lbs in carton.

### Optical System

- State-of-the-Art one piece silicone optic sheet delivers industry leading optical control with an integrated gasket to provide IP66 rated sealed optical chamber in 1 component.
- Proprietary silicone refractor optics provide exceptional coverage and uniformity in IES Types 2, 3, 5W, FT, FTA and AM.
- Silicone optical material does not yellow or crack with age and provides a typical light transmittance of 93%.
- Zero uplight.
- Available in 5000K, 4000K, and 3000K color temperatures per ANSI C78.377. Also Available in Phosphor Converted Amber with Peak intensity at 610nm.
- Minimum CRI of 70.
- Integral louver (IL) and integral half louver (IH) options available for enhanced back-light control.

### Electrical

- High-performance programmable driver features over-voltage, under-voltage, short-circuit and over temperature protection. Custom lumen and wattage packages available.
- 0-10V dimming (10% - 100%) standard.

- Standard Universal Voltage (120-277 Vac) Input 50/60 Hz or optional High Voltage (347-480 Vac).
- L90 Calculated Life: >100k Hours (See Lumen Maintenance chart)
- Total harmonic distortion: <20%
- Operating temperature: -40°C to +50°C (-40°F to +122°F). 65L and 78L lumen packages rated to +40°C.
- Power factor: >.90
- Input power stays constant over life.
- Field replaceable 10kV surge protection device meets a minimum Category C Low operation (per ANSI/IEEE C62.41.2).
- High-efficacy LEDs mounted to metal-core circuit board to maximize heat dissipation
- Components are fully encased in potting material for moisture resistance. Driver complies with FCC standards. Driver and key electronic components can easily be accessed.

### Controls

- Optional integral passive infrared Bluetooth<sup>™</sup> motion and photocell sensor (see page 5 for more details). Fixtures operate independently and can be commissioned via iOS or Android configuration app.
- LSI's AirLink<sup>™</sup> wireless control system options reduce energy and maintenance costs while optimizing light quality 24/7. (see controls section for more details).

### Installation

- Designed to mount to square or round poles.
- A single fastener secures the hinged door, underneath the housing and provides quick & easy access to the electrical compartment for installing/servicing.
- Included terminal block accepts up to 12 ga. wire.
- Utilizes both B3 and B5 drill patterns for easy fastening of LSI products.

### Warranty

- LSI luminaires carry a 5-year limited warranty. Refer to <https://www.lsicorp.com/resources/terms-conditions-warranty/> for more information.

### Listings

- Listed to UL 1598 and UL 8750.
- State of California Title 24 Compliant; with IMSBT, ALSC, or ALSCH Options.
- DesignLights Consortium<sup>®</sup> (DLC) qualified product. Not all versions of this product may be DLC qualified. Please check the DLC Qualified Products List at [www.designlights.org/QPL](http://www.designlights.org/QPL) to confirm which versions are qualified.
- Meets Buy American Act requirements.
- Dark Sky compliant; with 3000K color temperature selection.
- Suitable for wet locations.
- IP66 rated Luminaire per IEC 60598.
- 3G rated for ANSI C136.31 high vibration applications are qualified.
- IK08 rated luminaire per IEC 66262 mechanical impact code

# Mirada Large Outdoor LED Area Light

Type : \_\_\_\_\_

 **Have questions?** Call us at (800) 436-7800

## ORDERING GUIDE

[Back to Quick Links](#)

### TYPICAL ORDER EXAMPLE: MRL LED 40L SIL FTA L UNV DIM 50 70CRI ALSCS04 BRZ IL

Prefix	Light Source	Lumen Package	Lens	Distribution	Orientation <sup>2</sup>	Voltage
MRL - Mirada Large	LED	40L - 40,000 lms 50L - 50,000 lms 65L - 65,000 lms 78L - 78,000 lms  Custom Lumen Packages <sup>1</sup>	SIL - Silicone	2 - Type 2 3 - Type 3 5W - Type 5 Wide FT - Forward Throw FTA - Forward Throw Automotive AM - Automotive Merchandise	(blank) - Standard L - Optics rotated left 90° R - Optics rotated right 90°	UNV - Universal Voltage (120-277V) HV - High Voltage (347-480V)

Driver	Color Temperature	Color Rendering	Controls	Finish	Options
DIM - 0-10v Dimming (10-100%)	50 - 5,000 CCT 40 - 4,000 CCT 30 - 3,000 CCT AMB - Phosphor Converted Amber <sup>8</sup>	70CRI - 70 CRI	(Blank) - None  <b>Wireless Controls System</b> ALSDC - AirLink Synapse Control System ALSCS02 - AirLink Synapse Control System with 12-20' Motion Sensor ALSCS04 - AirLink Synapse Control System with 20-40' Motion Sensor ALSDC DB - AirLink Synapse Integral Controller and Dynamic Behaviors Drivers ALBMR1LR - AirLink Blue Long Range Wireless Motion & Photo Sensor Controller (8-15' mounting height) <sup>3</sup> ALBMR2LR - AirLink Blue Long Range Wireless Motion & Photo Sensor Controller (16-40' mounting height) <sup>3</sup>  <b>Stand-Alone Controls</b> EXT - 0-10V Dimming leads extended to housing exterior CR7P - 7 Pin Control Receptacle ANSI C136.41 <sup>4</sup> IMSBT1L - Integral Bluetooth <sup>SM</sup> Motion and Photocell Sensor (8-24' MH) <sup>5</sup> IMSBT2L - Integral Bluetooth <sup>SM</sup> Motion and Photocell Sensor (25-40' MH) <sup>5</sup>  <b>Button Type Photocells</b> PCI120 - 120V PCI208-277 - 208-277V PCI347 - 347V	BLK - Black BRZ - Dark Bronze GMG - Gun Metal Gray GPT - Graphite MSV - Metallic Silver PLP - Platinum Plus SVG - Satin Verde Green WHT - White	(Blank) - None IH - Integral Half Louver (Moderate Spill Light Cutoff) <sup>2</sup> IL - Integral Louver (Sharp Spill Light Cutoff) <sup>2</sup>



**Need more information?**  
[Click here for our glossary.](#)

**Have additional questions?**  
Call us at (800) 436-7800



## Accessory Ordering Information<sup>5</sup>

CONTROLS ACCESSORIES	
Description	Order Number
Twist Lock Photocell (120V) for use with CR7P <sup>6</sup>	122514
Twist Lock Photocell (208-277) for use with CR7P <sup>6</sup>	122515
Twist Lock Photocell (347V) for use with CR7P <sup>6</sup>	122516
Twist Lock Photocell (480V) for use with CR7P <sup>6</sup>	1225180
AirLink 5 Pin Twist Lock Controller <sup>6</sup>	661409
AirLink 7 Pin Twist Lock Controller <sup>6</sup>	661410
AirLink Synapse Central Base Station	TBD
AirLink Synapse Remote Access 12 month subscription	TBD
AirLink Synapse Dynamic Behavior Software	TBD
Shorting Cap for use with CR7P <sup>6</sup>	149328

FUSING OPTIONS <sup>7</sup>	
Single Fusing (120V)	<a href="#">See Fusing Accessory Guide</a>
Single Fusing (277V)	
Double Fusing (208V, 240V)	
Double Fusing (480V)	
Double Fusing (347V)	

EXTERNAL SHIELDING OPTIONS	
3" External Shield	<a href="#">See Shielding Guide</a>
6" External Shield	

1. Custom lumen and wattage packages available, consult factory. Values are within industry standard tolerances but not DLC listed.  
2. Not available with 5W distribution  
3. Motion sensors are field configurable via an app that can be downloaded from your smartphone's native app store.  
4. Control device or shorting cap must be ordered separately. See Accessory Ordering Information.

5. Accessories are shipped separately and field installed.  
6. Factory installed CR7P option required. See Options.  
7. Fusing must be located in hand hole of pole. See [Fusing Accessory Guide](#) for compatibility.  
8. Only available in 40L Lumen Package. Consult factory for lead time and availability.

Have questions? Call us at (800) 436-7800

## ACCESSORIES

MOUNTING ACCESSORIES		SHIELDING, POLES & MISC. ACCESSORIES		
Side Arm	<b>Universal Mounting Bracket</b> Mounts to $\geq 3"$ square or round (tapered/straight) poles with (2) mounting hole spaces between 3.5" to 5" <b>Part Number: BKA UMB CLR</b>		<b>Shielding</b> <b>Integral Louver</b> Field Install Integral Louver provides maximum backlight control by shielding each individual row of LEDs <b>Part Number: 686485</b> 	
	<b>Quick Mount Plate</b> True one person installation to existing/new construction poles with hole spaces between 2.4 to 4.6" <b>Part Number: BKS PQM B3B5 XX CLR</b>			<b>Integral Half Louver</b> Field Install Integral Half Louver provides great backlight control without impacting front side distribution. <b>Part Number: 743416</b> 
	<b>15° Tilt Quick Mount Plate</b> True one person installation to existing/new construction poles with hole spaces between 2.4 to 4.6" <b>Part Number: BKS PQ15 B3B5 XX CLR</b>			<b>External Shield</b> External shield blocks view of light source from any side of luminaire, additional shielding configurations available <b>Part Number: 785970BLK (3") / 785962BLK (6")</b> 
Tenon / Slipfitter	<b>Adjustable Slipfitter</b> Mounts onto a 2" (51mm) IP, 2.375" (60mm) O.D. tenon and provides 180° of tilt (max 45° above horizontal) <b>Part Number: BKA ASF CLR</b>		<b>Poles</b> <b>Square Poles</b> 14 - 39' steel and aluminum poles in 4", 5" and 6" sizes for retrofit and new construction <b>Part Number: 45Q/55Q/65Q</b> 	
	<b>Square Tenon Top</b> Mounts onto a 2" (51mm) IP, 2.375" (60mm) O.D. tenon and allows for mounting up to 4 luminaires <b>Part Number: BKA XNM *</b>			<b>Round Poles</b> 10 - 30' steel and aluminum poles in 4" and 5" sizes for retrofit and new construction <b>Part Number: 4RP/5RP</b> 
	<b>Square Internal Slipfitter</b> Mounts inside 4" or 5" square pole and allows for mounting up to 4 luminaires <b>Part Number: BKA X_ISF * CLR</b>			<b>Tapered Poles</b> 20' - 39' steel and aluminum poles for retrofit and new construction <b>Part Number: RTP</b> 
Wall Mount / Wood Pole	<b>Wall Mount Bracket</b> Mounts onto vertical wall surface ( hardware/anchors not included) <b>Part Number: BKS XBO WM CLR</b>		<b>Misc.</b> <b>Bird Spikes</b> 10' linear bird spike (4' recommended per luminaire) silicone adhesive and application tool <b>Spike Part Number: 751631</b> <b>Adhesive Part Number: 751632</b> <b>Caulk Gun Part Number: 751636</b> 	
	<b>Wood Pole Bracket</b> Mounts onto wooden poles (6" minimum OD, hardware/anchors not included) <b>Part Number: BKS XBO WP CLR</b>			

Replace CLR with paint finish description  
 Replace XX with SQ for square pole or RD for round pole ( $\geq 3"$  OD)  
 Replace \* with S (Single), D180 (Double @180°), D90 (Double @90°), T90 (Triple), Q90 (Quad)  
 Replace \_ with 4 (4" square pole) or 5 (5" square pole)

## OPTICS ROTATION

Top View

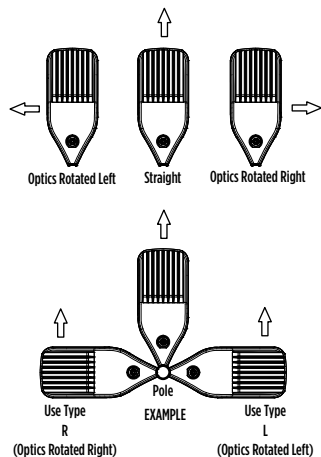

## ACCESSORIES/OPTIONS

### Integral Louver (IL) and House-Side Shield (IH)

Integral louver (IL) and half louver (IH) accessory shields available for improved backlight control without sacrificing street side performance. LSI's Integral Louver (IL) and Integral House-Side Shield (IH) options deliver backlight control that significantly reduces spill light behind the poles for applications with pole locations close to adjacent properties. The design maximizes forward reflected light while reducing glare, maintaining the optical distribution selected, and most importantly eliminating light trespass. Both options rotate

Luminaire Shown with Integral Louver (IL)



Luminaire Shown with IMSBT Option



### 7 Pin Photoelectric Control

7-pin ANSI C136.41-2013 control receptacle option available for twist lock photocontrols or wireless control modules. Control accessories sold separately. Dimming leads from the receptacle will be connected to the driver dimming leads (Consult factory for alternate wiring).

Luminaire Shown with CR7P



# Mirada Large Outdoor LED Area Light

Type : \_\_\_\_\_

 Have questions? Call us at (800) 436-7800

## PERFORMANCE

[Back to Quick Links](#)

DELIVERED LUMENS*												
Lumen Package	Distribution	CRI	3000K CCT			4000K CCT			5000K CCT			Wattage
			Delivered Lumens	Efficacy	BUG Rating	Delivered Lumens	Efficacy	BUG Rating	Delivered Lumens	Efficacy	BUG Rating	
40L	2	70	39770	139	B5-U0-G4	41255	144	B5-U0-G4	42864	150	B5-U0-G4	286
	3		40747	142	B5-U0-G4	42269	148	B4-U0-G4	43917	154	B4-U0-G4	
	5W		40392	141	B5-U0-G4	41901	147	B5-U0-G4	43535	152	B5-U0-G4	
	FT		40342	141	B4-U0-G4	41848	146	B4-U0-G5	43480	152	B4-U0-G5	
	FTA		40673	142	B4-U0-G4	42192	148	B4-U0-G4	43838	153	B4-U0-G4	
	AM		40823	143	B4-U0-G3	42347	148	B4-U0-G3	43998	154	B4-U0-G3	
50L	2	70	49372	132	B5-U0-G4	51216	137	B5-U0-G4	53213	142	B5-U0-G4	375
	3		50586	135	B4-U0-G5	52475	140	B4-U0-G5	54521	145	B4-U0-G5	
	5W		50145	134	B5-U0-G4	52018	139	B5-U0-G4	54047	144	B5-U0-G4	
	FT		50082	134	B4-U0-G5	51952	139	B4-U0-G5	53978	144	B4-U0-G5	
	FTA		50493	135	B5-U0-G4	52379	140	B5-U0-G4	54422	145	B5-U0-G4	
	AM		50680	135	B4-U0-G3	52572	140	B4-U0-G3	54622	146	B4-U0-G3	
65L	2	70	63328	122	B5-U0-G4	65692	127	B5-U0-G5	68255	132	B5-U0-G5	518
	3		64884	125	B5-U0-G5	67307	130	B5-U0-G5	69932	135	B5-U0-G5	
	5W		64320	124	B5-U0-G5	66722	129	B5-U0-G5	69324	134	B5-U0-G5	
	FT		64239	124	B5-U0-G5	66638	129	B5-U0-G5	69237	134	B5-U0-G5	
	FTA		64766	125	B5-U0-G5	67185	130	B5-U0-G5	69805	135	B5-U0-G5	
	AM		65005	125	B4-U0-G3	67432	130	B5-U0-G3	70062	135	B5-U0-G3	
78L	2	70	74667	115	B5-U0-G5	77456	120	B5-U0-G5	80476	124	B5-U0-G5	648
	3		74667	115	B5-U0-G5	77455	120	B5-U0-G5	80476	124	B5-U0-G5	
	5W		74018	114	B5-U0-G5	76782	118	B5-U0-G5	79777	123	B5-U0-G5	
	FT		73925	114	B5-U0-G5	76685	118	B5-U0-G5	79676	123	B5-U0-G5	
	FTA		74532	115	B5-U0-G5	77315	119	B5-U0-G5	80330	124	B5-U0-G5	
	AM		74805	115	B5-U0-G3	77599	120	B5-U0-G3	80625	124	B5-U0-G3	

\*LEDs are frequently updated therefore values are nominal.

DELIVERED LUMENS*				
Lumen Package	Distribution	Phosphor Converted Amber (Peak 610nm)		
		Delivered Lumens	Efficacy	BUG Rating
40L	2	18519	60	B3-U0-G3
	3	18895	61	B3-U0-G3
	5W	18512	60	B5-U0-G3
	FT	19035	62	B2-U0-G2
	FTA	18366	59	B3-U0-G3
	AM	18695	61	B3-U0-G3

Electrical Data (Amps)*						
Lumens	120V	208V	240V	277V	347V	480V
40L	2.38	1.38	1.19	1.03	0.82	0.60
50L	3.13	1.80	1.56	1.35	1.08	0.78
65L	4.32	2.49	2.16	1.87	1.49	1.08
78L	5.40	3.12	2.70	2.34	1.87	1.35

\*Electrical data at 25°C (77°F). Actual wattage may differ by +/-10%

RECOMMENDED LUMEN MAINTENANCE <sup>1</sup>					
Ambient	Initial <sup>2</sup>	25h <sup>2</sup>	50hr <sup>2</sup>	75hr <sup>2</sup>	100hr <sup>2</sup>
0 C - 40C	100%	100%	97%	94%	92%

- Lumen maintenance values at 25C are calculated per TM-21 based on LM-80 data and in-situ testing.
- In accordance with IESNA TM-21-11, Projected Values represent interpolated value based on time durations that are within six times the IESNA LM-80-08 total test duration for the device under testing.
- In accordance with IESNA TM-21-11, Calculated Values represent time durations that exceed six times the IESNA LM-80-08 total test duration for the device under testing.

# Mirada Large Outdoor LED Area Light

Type : \_\_\_\_\_

 Have questions? Call us at (800) 436-7800

## PHOTOMETRICS

[Back to Quick Links](#)

Luminaire photometry has been conducted by an accredited laboratory in accordance with IESNA LM-79. As specified by IESNA LM-79 the entire luminaire is tested as the source resulting in a luminaire efficiency of 100%.

See <https://www.lsicorp.com/product/mirada-large/> for detailed photometric data.

### MRL-LED-65L-SIL-2-40-70CRI

Luminaire Data	
Type 2 Distribution	
Description	4000 Kelvin, 70 CRI
Delivered Lumens	65,693
Watts	518
Efficacy	127
IES Type	Type II - Short
BUG Rating	B5-U0-G5

Zonal Lumen Summary		
Zone	Lumens	% Luminaire
Low (0-30°)	10825	16%
Medium (30-60°)	41026	62%
High (60-80°)	13243	20%
Very High (80-90°)	598	1%
Uplight (90-180°)	0	0%
<b>Total Flux</b>	<b>65693</b>	<b>100%</b>

ISO Footcandle

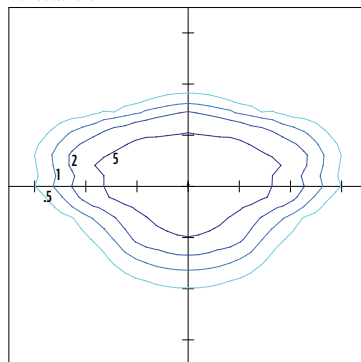

Polar Curve

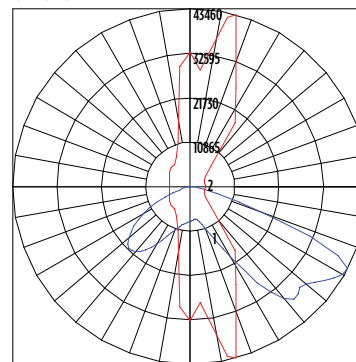

### MRL-LED-65L-SIL-3-40-70CRI

Luminaire Data	
Type 3 Distribution	
Description	4000 Kelvin, 70 CRI
Delivered Lumens	67,307
Watts	518
Efficacy	130
IES Type	Type III - Short
BUG Rating	B5-U0-G5

Zonal Lumen Summary		
Zone	Lumens	% Luminaire
Low (0-30°)	6980	10%
Medium (30-60°)	37817	56%
High (60-80°)	21783	32%
Very High (80-90°)	727	1%
Uplight (90-180°)	0	0%
<b>Total Flux</b>	<b>67307</b>	<b>100%</b>

ISO Footcandle

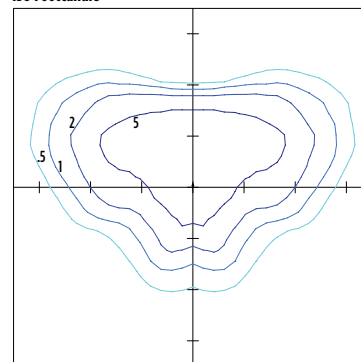

Polar Curve

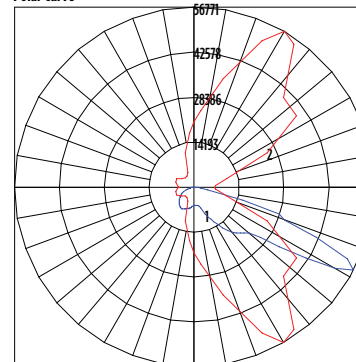

### MRL-LED-65L-SIL-FT-40-70CRI

Luminaire Data	
Type FT Distribution	
Description	4000 Kelvin, 70 CRI
Delivered Lumens	66,638
Watts	518
Efficacy	129
IES Type	Type IV - Short
BUG Rating	B5-U0-G5

Zonal Lumen Summary		
Zone	Lumens	% Luminaire
Low (0-30°)	8542	13%
Medium (30-60°)	33055	50%
High (60-80°)	23973	36%
Very High (80-90°)	1069	2%
Uplight (90-180°)	0	0%
<b>Total Flux</b>	<b>66638</b>	<b>100%</b>

ISO Footcandle

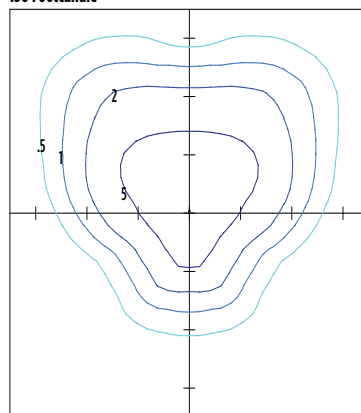

Polar Curve

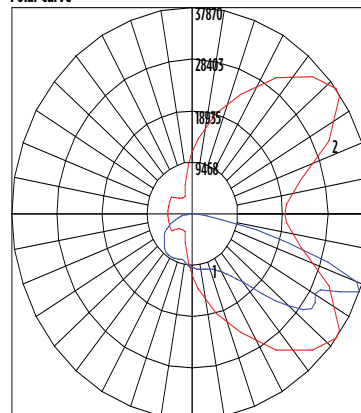

# Mirada Large Outdoor LED Area Light

Type : \_\_\_\_\_

 Have questions? Call us at (800) 436-7800

## PHOTOMETRICS (CONT)

[Back to Quick Links](#)

### MRL-LED-65L-SIL-5W-40-70CRI

Luminaire Data	
Type SW Distribution	
Description	4000 Kelvin, 70 CRI
Delivered Lumens	66,722
Watts	518
Efficacy	129
IES Type	Type VS - Short
BUG Rating	B5-U0-G5

Zonal Lumen Summary		
Zone	Lumens	% Luminaire
Low (0-30°)	6379	10%
Medium (30-60°)	33102	50%
High (60-80°)	26808	40%
Very High (80-90°)	433	1%
Uplight (90-180°)	0	0%
<b>Total Flux</b>	<b>66722</b>	<b>100%</b>

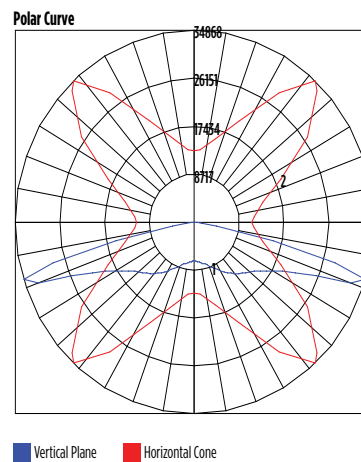
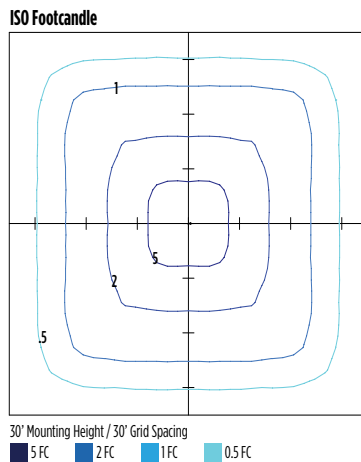

### MRL-LED-65L-SIL-FTA-40-70CRI

Luminaire Data	
Type FTA Distribution	
Description	4000 Kelvin, 70 CRI
Delivered Lumens	67,185
Watts	518
Efficacy	130
IES Type	Type I - Very Short
BUG Rating	B5-U0-G5

Zonal Lumen Summary		
Zone	Lumens	% Luminaire
Low (0-30°)	14876	22%
Medium (30-60°)	39340	59%
High (60-80°)	12095	18%
Very High (80-90°)	874	1%
Uplight (90-180°)	0	0%
<b>Total Flux</b>	<b>67185</b>	<b>100%</b>

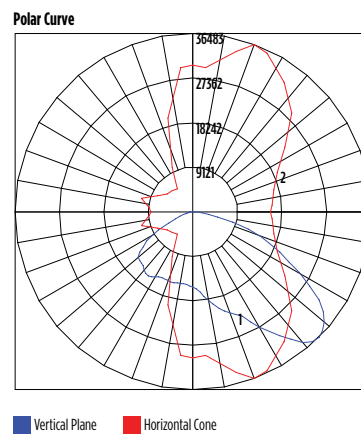
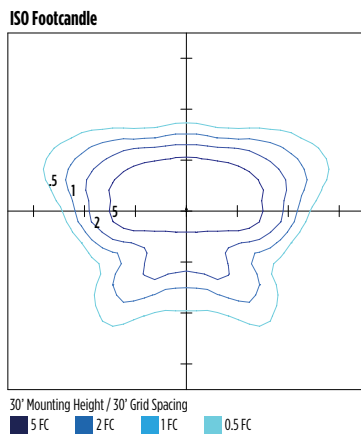

### MRL-LED-65L-SIL-AM-40-70CRI

Luminaire Data	
Type AM Distribution	
Description	4000 Kelvin, 70 CRI
Delivered Lumens	67,432
Watts	518
Efficacy	130
IES Type	Type III - Very Short
BUG Rating	B5-U0-G3

Zonal Lumen Summary		
Zone	Lumens	% Luminaire
Low (0-30°)	13837	9%
Medium (30-60°)	44654	43%
High (60-80°)	8162	48%
Very High (80-90°)	779	1%
Uplight (90-180°)	0	0%
<b>Total Flux</b>	<b>67432</b>	<b>100%</b>

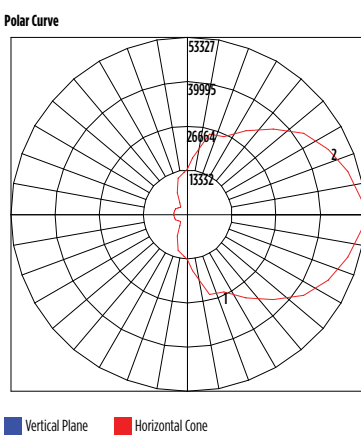
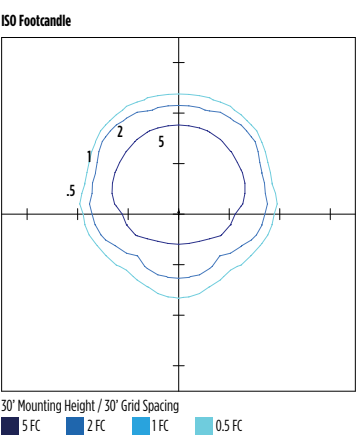

# Mirada Large Outdoor LED Area Light





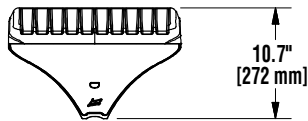
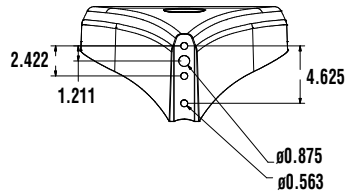
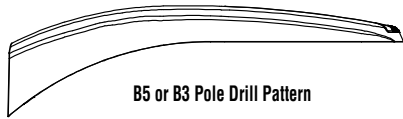
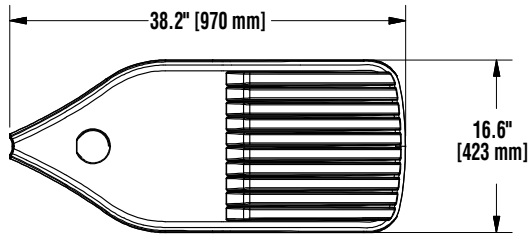

Type : \_\_\_\_\_

 Have questions? Call us at (800) 436-7800

## PRODUCT DIMENSIONS

[Back to Quick Links](#)



Luminaire EPA Chart					
Tilt Degree		0°	15°	30°	45°
	Single	0.8	1.5	2.2	2.9
	D180°	1.6	2.3	2.2	2.9
	D90°	1.2	2.5	3.0	3.7
	T90°	2.0	2.3	3.8	4.5
	TN120°	2.0	3.0	5.0	6.0
	O90°	2.0	2.3	3.8	4.5



# Mirada Large Outdoor LED Area Light

Type : \_\_\_\_\_

 **Have questions?** Call us at (800) 436-7800

## CONTROLS

[Back to Quick Links](#)

### Integral Bluetooth™ Motion and Photocell Sensor (IMSBTxL)

Slim low profile sensor provides multi-level control based on motion and/or daylight. Sensor controls 0-10 VDC LED drivers and is IP66 rated for cold and wet locations (-40°F to 167°F). Two unique PIR lenses are available and used based on fixture mounting height. All control parameters are adjustable via an iOS or Android App capable of storing and transmitting sensor profiles.

[Click here to learn more details about IMSBT](#)



LEVITON App



Apple



Android

### (ALBMRxLR, ALBCSx)

Wireless Bluetooth Mesh Outdoor Lighting Control System that provides energy savings, code compliance and enhanced safety/security for parking lots and parking garages. Three key components; Bluetooth wireless radio/sensor controller, Time Keeper and an iOS App. Capable of grouping multiple fixtures and sensors as well as scheduling time-based events by zone. Radio/Sensor Controller is factory integrated into Area/ Site, Wall Mounted, Parking Garage and Canopy luminaires.

[Click here to learn more details about AirLink Blue](#)



AirLink Blue App



Apple

### Sensor Sequence of Operations

Standard Programming	On Event	Off Event	On Light Level	Dim Light Level	Daylight Harvesting	Delay To Off	Sensitivity
OMSBTxL/IMSBTxL	Motion	No Motion	100%	N/A	On; Auto Calibration	20 minutes	High
OMS	Motion	No Motion	N/A	N/A	N/A	30 seconds	Auto

Operation	Description
<b>On Event</b>	Trigger that activates lights to turn on; either automatic via motion detected or manually activated via push of button.
<b>Off Event</b>	Trigger that activates lights to turn off; either automatic via no motion detected or manually activated via push of button.
<b>On Light Level</b>	The light level that the fixtures will turn on to when ON EVENT occurs.
<b>Dim Light Level</b>	The light level that the fixtures will dim down to when no motion is detected.
<b>Delay to Dim</b>	The amount of time after which no motion is detected that the fixtures will be triggered to dim down. This sequence is optional, and sensor can be programmed to only trigger the fixture to turn off by entering 100% in this field.
<b>Delay to Off</b>	The amount of time after which no motion is detected that the fixtures will be triggered to turn off. If delay to dim is part of the programmed functionality, this is the amount of time after which no motion is detected after the fixture have already dimmed down.
<b>Sensitivity</b>	The sensitivity can be set to high, medium, low, or auto where applicable. High will detect smaller, simple motions. Low will only detect larger more complex motions. Auto temperature calibration adjusts the PIR sensitivity as ambient temperature rises to increase detection of heat movement through the field of view.