

3-DOOR LOW-PROFILE BAKERY CASE



140 Park Street • Milo, Maine 04463 • 800.332.5507 TEL • 207.943.5632 FAX • JSISTOREFIXTURES.COM
Milo, Maine • Bangor, Maine • Suwanee, Georgia • Payson, Utah • Greenville, South Carolina • Collingwood, Ontario

3-DOOR LOW-PROFILE BAKERY CASE

DESCRIPTION

Our Bakery Cases are built for presentation. The doors match standard tray widths allowing for easier merchandising and customer access. Standard LED lighting provides an energy-efficient, long-lasting lighted display. Our modular shelving design makes daily cleaning quick and easy.

3-DOOR LOW-PROFILE BAKERY CASE WITH OPTIONAL BUMPER

FEATURES

- 3 Adjustable Wire Shelves with PTM
- Capacity: (9) Standard 18"W X 26"D Pastry Trays
- Shelves Adjust for 2 Sloped Positions
- 18" Wide Doors Align Perfectly with Standard 18"L X 26"D Pastry Trays
- LED Lighting on 3 Shelves
- Packaging Ledge with Bag Holder
- Black Tissue Holder and Trash Receptacle
- Removable Toe Kick and Leg Levelers for Easy Installation
- Available with Solid Back Panel or Sliding Rear Doors
- Variety of Materials/Finishes/Options

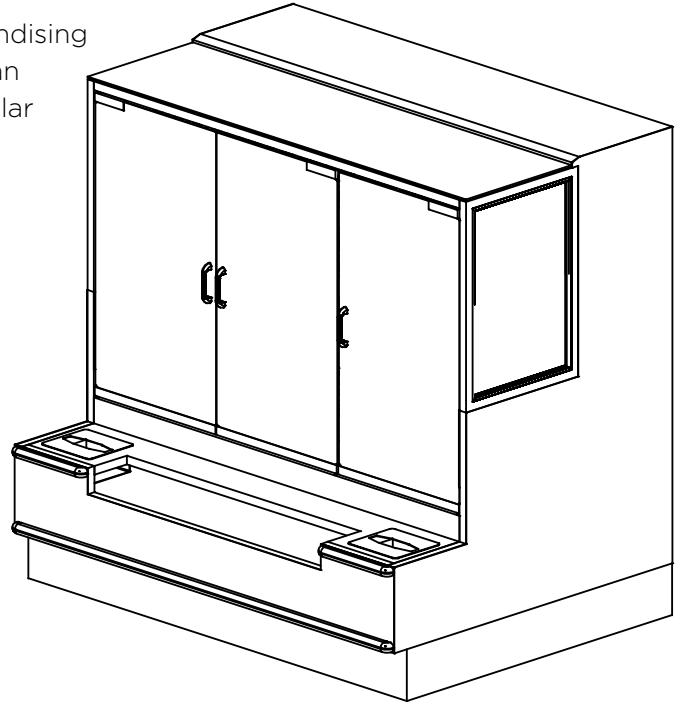

APPLICATIONS

- Use as a Stand-Alone for Loose and Packaged Items or in a Line-Up

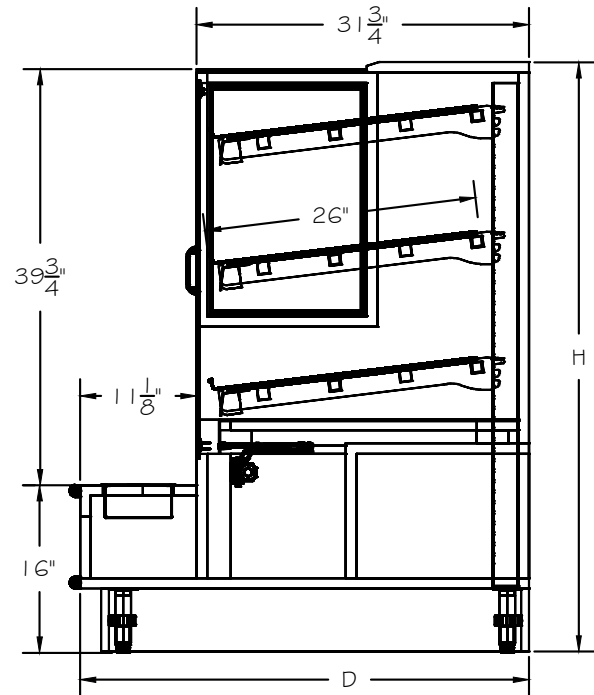
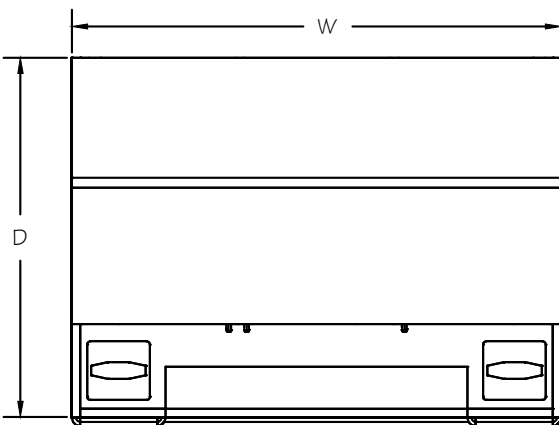

See our 2-door and 3-door specification sheets for alternate capacity needs.

STYLE	ITEM #	SIZES W x D x H
3-DOOR LOW-PROFILE BAKERY CASE	C-DC3-594356	58 1/2" X 43" X 56"

MATERIALS, FINISHES, FOAM, AND ACCESSORIES

Please refer to our "Styles, Groupings, Stains, and Accessories" brochure to see our wide range of materials, finishes, and accessories.