

POLE 
BASICS



TABLE OF CONTENTS

Steel Poles	Page 3
Aluminum Poles	Page 4
Drill Patterns	Page 5
Brackets	Page 6
Accessories	Page 10
Base Covers	Page 11
Anchor Bolts.....	Page 14
Windspeed Map.....	Page 16





Standard Square

4", 5", 6"

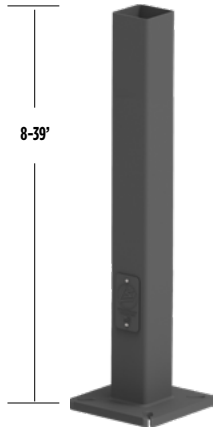

Standard Round

4", 5"

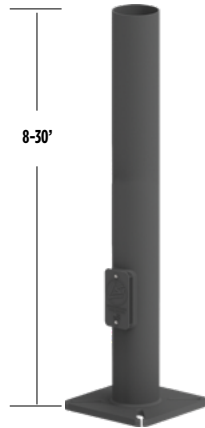

Standard Round Tapered

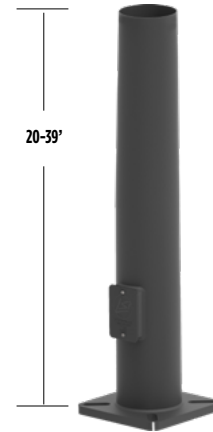

Pole Foundation Illustration

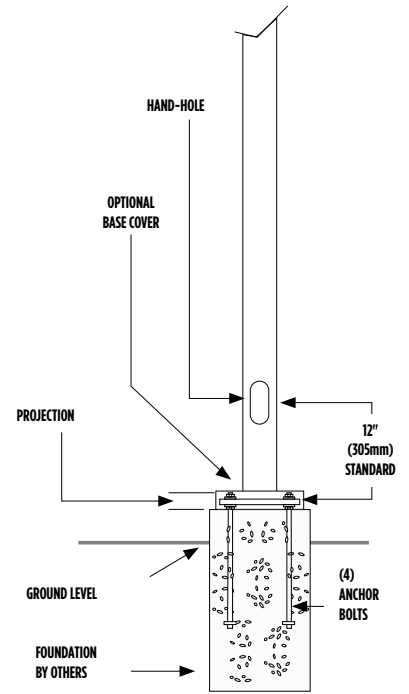

Universal Square

4", 5", 6"

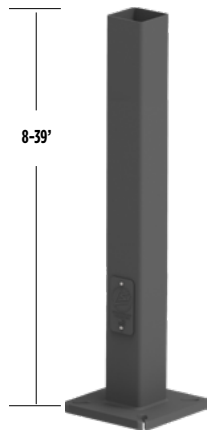

Universal Round

4", 5"

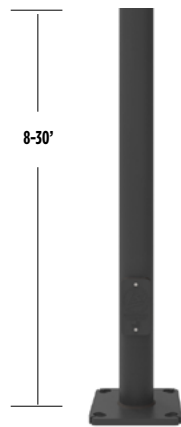

Universal Round Tapered

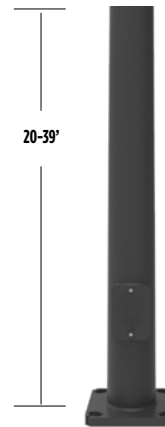

Direct Burial Foundation Illustration

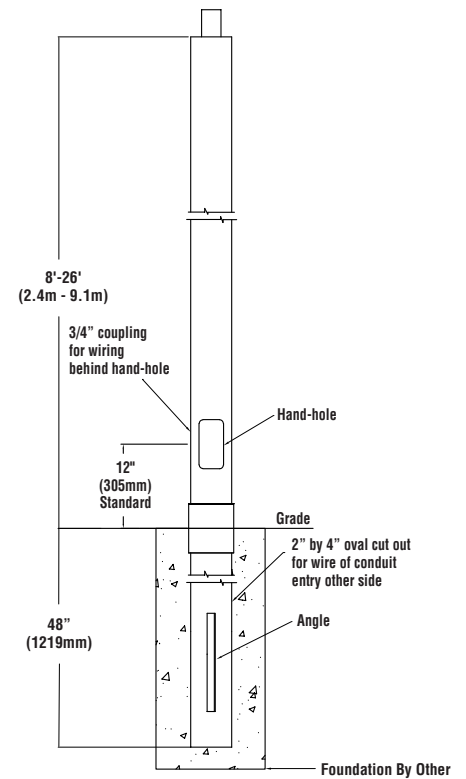

Direct Burial Square

4", 5"

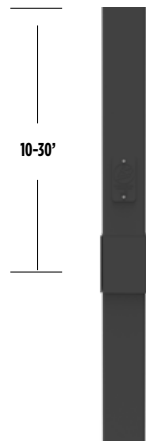

Direct Burial Round

4", 5"





Aluminum Round

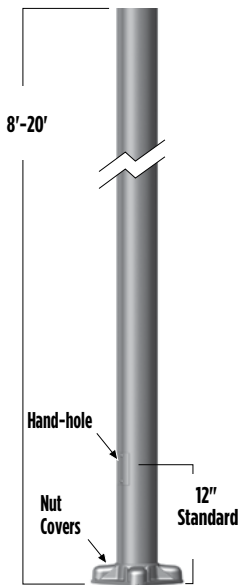

Aluminum Square (Soft Corner)

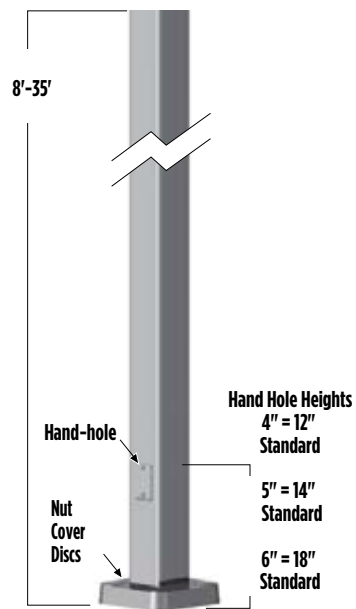

Aluminum Round Tapered

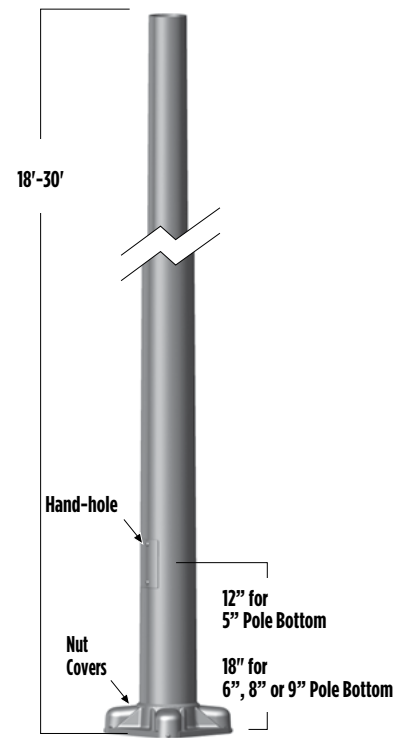

Aluminum Round Hinged Base

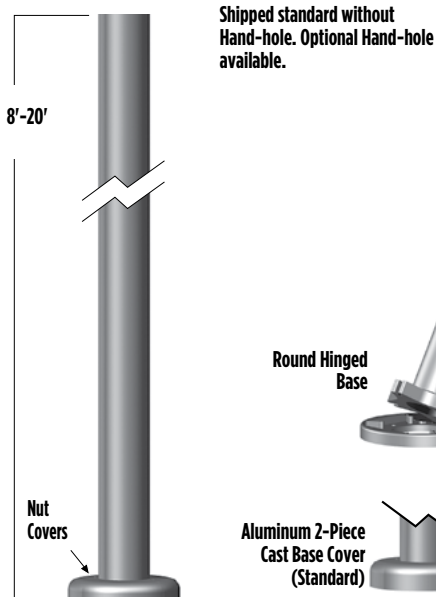

Aluminum Fluted Round with Decorative Base

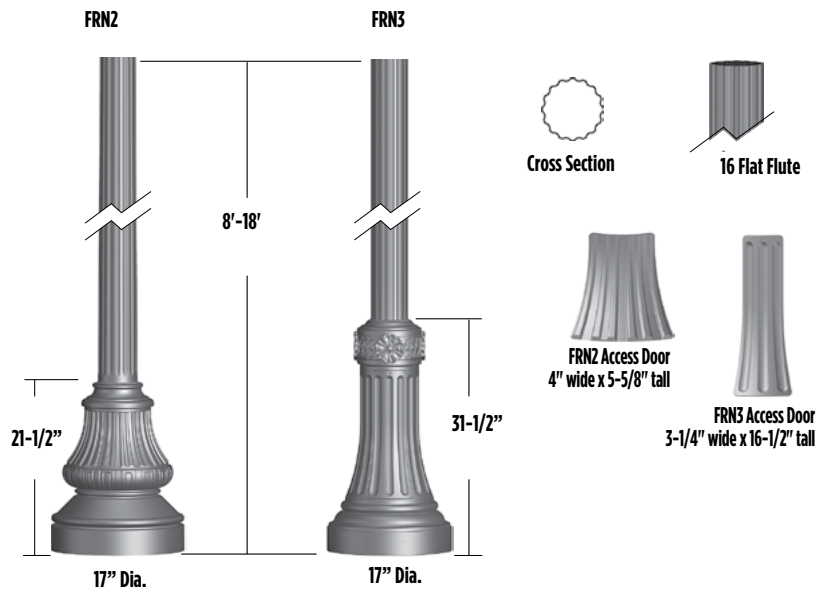



3" - B3 Drilling Pattern

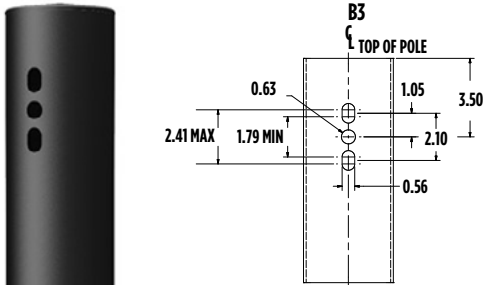

ROUND POLES - 4RP B3 / 5RP B3 / RTP B3
 SQUARE POLES - 4SQ B3 / 5SQ B3 / 6SQ B3

UNIVERSAL REPLACEMENT ROUND POLES
 4RPU B3 / 5RPU B3 / RTPU B3
 UNIVERSAL REPLACEMENT SQUARE POLES
 4SQU B3 / 5SQU B3 / 6SQU B3

5" - B5 Drilling Pattern

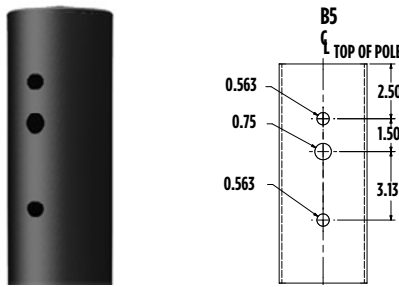

ROUND POLES - 4RP B5 / 5RP B5 / RTP B5
 SQUARE POLES - 4SQ B5 / 5SQ B5 / 6SQ B5

UNIVERSAL REPLACEMENT ROUND POLES
 4RPU B5 / 5RPU B5 / RTPU B5
 UNIVERSAL REPLACEMENT SQUARE POLES
 4SQU B5 / 5SQU B5 / 6SQU B5

2" - B2 Drilling Pattern

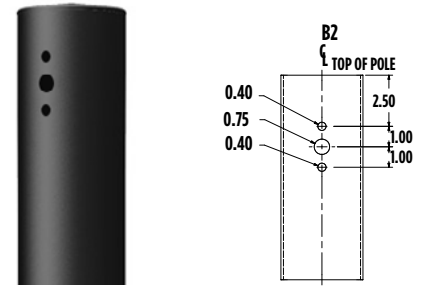

ROUND POLES - 4RP B2 / 5RP B2 / RTP B2
 SQUARE POLES - 4SQ B2 / 5SQ B2 / 6SQ B2

UNIVERSAL REPLACEMENT ROUND POLES
 4RPU B2 / 5RPU B2 / RTPU B2
 UNIVERSAL REPLACEMENT SQUARE POLES
 4SQU B2 / 5SQU B2 / 6SQU B2

N Tenon Mounting Configuration

4RPN / 5RPN / 4SQN / 5SQN / 6SQN with N Tenon Configuration

Select this Tenon Mounting Configuration to use with vertically mounted tenon brackets shown on pages titled:

- Tenon Brackets and Reducers

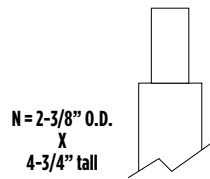

4N Tenon Mounting Configuration

5RPN with N Tenon Configuration

4N Tenon Mount Configuration is available with 5RPN only.

4N = 4" O.D.
 X
 4-7/8" tall

4N-6 Tenon Mount Configuration is available with 5RPN only.

4N-6 = 4" O.D.
 X
 6" tall

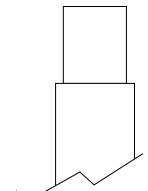

Drilling Locations

Sides	A	B	C	D
Hand-hole	X			
Single	X			
D180		X		X
D90	X			X
DN90				
T90	X	X		X
TN120				
Q90	X	X	X	X
QN90				
Single FBO	X			
Double FBO		X		X

Note: Consult factory for custom variations. Standard SF and DF pole preparations are located 3/4 of the height of the pole from the base, unless otherwise specified (except on 20' Round Tapered pole - Maximum height for SF & DF is 13' from the base). To specify alternate height SF_ or DF_.

Fixture Configurations

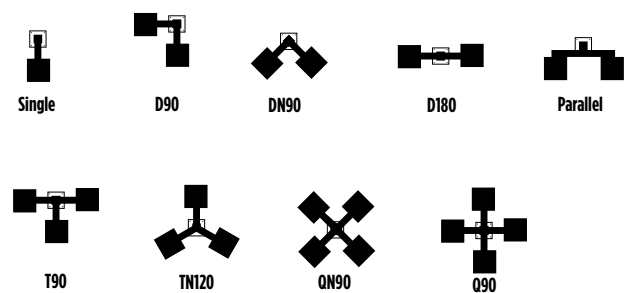

Square Poles:
 TN/DN/QN mounting is approximately 10" taller than the pole shaft.





B3 Brackets



BKA XBO EC 6 CLR
EXTENSION ARM - Aluminum 3" reduced drill pattern. Use this 6" extension arm to position the fixture further from the pole. Not for use with Mirada Series or decorative area lights.
Part #382136CLR

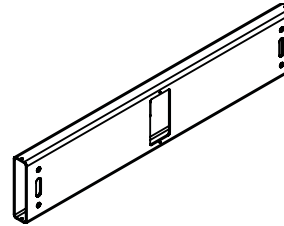

BKS XBO PA40 CLR - Parallel Arm
1 piece steel 3" drill pattern designed for direct mounting of fixture to face of bracket.
Part # 649603CLR



X3RPP CLR
Round tapered pole plate for round tapered poles
Part #408273CLR

X4RPP CLR
Round pole plate for 4" round poles
Part # 379967CLR

X5RPP CLR
Round pole plate for 5" round poles
Part # 379968CLR

B5 Brackets



BKA BO S (6, 8, or 12) CLR R
Aluminum Mounting Arm
Not for use with XSB, Patriot, Hilton or XLCL.
(Round pole applications use RPP2)
6" Part # 16196601CLR
8" Part # 16196604CLR
12" Part # 16196602CLR



RPP2 CLR - Round Pole Plate
Part # 162914CLR

2-1/2" x 5-3/8" x 6" | 2-1/2" x 5-3/8" x 8" | 2-1/2" x 5-3/8" x 12"

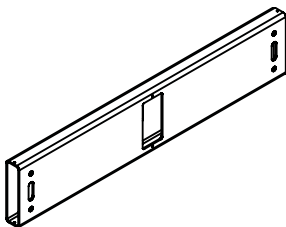

BKS BO PA40 CLR - Parallel Arm
1 piece steel 5" traditional drill pattern designed for direct mounting of fixture to face of bracket. Standard arms are not required except for Hilton Series.
Part # 141028CLR



BKU BO S 19 CLR - Upsweep Arm
3 piece aluminum 5" traditional drill pattern.
Part # 144191CLR

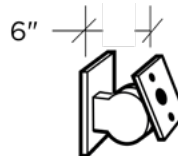

BKA BO ADJ 6 CLR - Adjustable Bracket
Aluminum 5" traditional drill pattern (both sides) - Standard arm is not used. Cannot be used with top-access fixtures, Patriot, XSB or XLCL. For use with square pole only.
Part # 130526CLR





Flood Brackets

For use with SF and DF pole shaft preparations

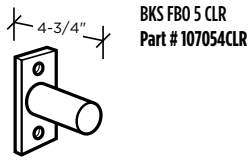

BKS FBO 5 CLR
Part # 107054CLR

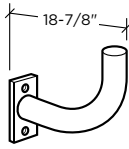

BKS FBO 18 CLR
Part # 107053CLR

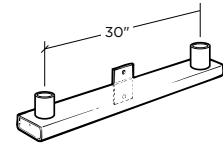

BKS FBO 30 CLR
Part # 133163CLR

SF and DF steel pole shaft preparations to be used with FBO brackets above.

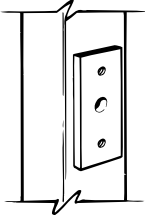

Square Poles

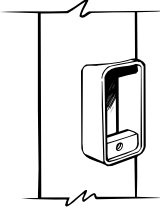

Round & Round Tapered Poles

Quick Mount Brackets

Pole quick mounts with universal mounting plate for one person installation. Can mount to LSI's and most competitors drill patterns.



BKS PQMH B3B5 SQ CLR
Part# 687073CLR

BKS PQMH B3B5 RND CLR
Part# 689903CLR

BKS PQMH B2 SQ CLR
Part# 751534CLR



15° Angle - PMQ15 allows 15° uptilt of fixture for greater throw of light with increased vertical illumination.

BKS PQM15 B3B5 SQ CLR
Part# 688003CLR

BKS PQM15 B3B5 RND CLR
Part# 689905CLR

BKS PQM15 B2 SQ CLR
Part# 740022CLR

Retrofit Brackets

Use to convert poles with existing 5" (127mm) Traditional 2-hole, 3-hole and 4-hole LSI drilling patterns to use with fixtures with 3" reduced drill pattern.



BKA UMB CLR
Part# 669230CLR

Allows you to seamlessly integrate LSI luminaires onto existing/new construction ≥ 3" square or round (tapered/straight) poles with (2) mounting hole spaces between 3.5" to 5".

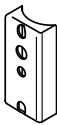

5-9/16" x 2-5/8"

BKS XBO ADP 2H CLR
Part# 388239CLR

To convert 2-hole 5" traditional LSI drilling pattern on round or square poles.

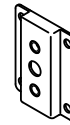

4-3/4" x 3-3/4"

BKS XBO ADP 4H CLR
Part# 388060CLR

To convert 4-hole LSI drilling pattern on square poles.

When ordering adaptors for 3- and 4-hole drilled square poles, ordering a replacement cap is also recommended due to the aging of the existing plastic pole cap. See part numbers on pg. 10.





POLE BASICS | TENON BRACKETS AND REDUCERS

SQN, RPN, FRN, RHPN, RTPN with N Tenon (2 3/8" O.D. x 4 3/4" or 4" tall)

Tenon Mount Fitters with 3" Reduced Drill Pattern



- BKA XNM S CLR
Part #408975CLR
- BKA XNM D180 CLR
Part# 422779CLR
- BKA XNM D90 CLR
Part# 422936CLR
- BKA XNM T90 CLR
Part# 480988CLR
- BKA XNM Q90 CLR
Part# 448380CLR

Tenon Mount Fitters with 5" Traditional Drill Pattern



- For flat surface brackets.
BKA NM S CLR
Part# 137839CLR
- BKA NM D180 CLR
Part# 43549CLR
- BKA NM D90 CLR
Part# 137840CLR
- BKA NM T90 CLR
Part# 137841CLR
- BKA NM Q90 CLR
Part# 43548CLR

Tenon Mount Fitters with TN120 Drill Pattern



- Drill 3 sides at 120°.
For radius surface brackets.
- 3" Reduced Drill Pattern
BKA XRNM TN120 SLM CLR
Part# 733993CLR
- 5" Reduced Drill Pattern
BKA RNM TN120 CLR
Part# 107023CLR

Tenon Mount Adjustable with 5" Traditional Drill Pattern

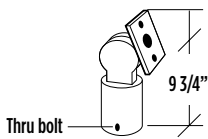

- BKA NM ADJ * CLR
Aluminum round slipfitter for 2-3/8" O.D. or 2-7/8" O.D. tenon - should not be used with standard arm. Cannot be used with top-access fixtures XLCL or Hilton Series.
Part # - 130527CLR

Tenon Mount Parallel Arm

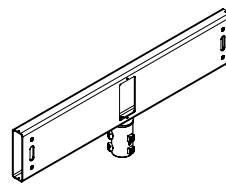

- 3" Reduced Drill Pattern
BKS XNM PA40 CLR
Part# 422898CLR
- 5" Reduced Drill Pattern
BKS NM PA40 CLR
Part# 143888CLR

2" x 8" x 40"

One piece steel arm, round slipfitter for 2 3/8" O.D. tenon. Designed for direct mounting of fixtures to face of bracket. Standard arm is not required, except for Hilton Series.

Flood Brackets - Used With Tenon Mount Poles

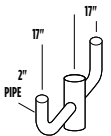

BKS-PTB-2-CLR
Part# 107066CLR

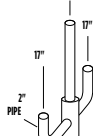

BKS-PTB-3-CLR
Part# 107070CLR

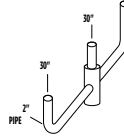

BKS-PTB-3-30-CLR
Part# 133505CLR

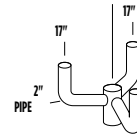

BKS-PTB-3-120-CLR
Part# 107067CLR

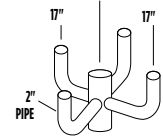

BKS-PTB-4-CLR
Part# 123109CLR

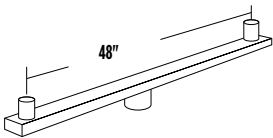

BKS-PTB-12-CLR
Part# 137105CLR

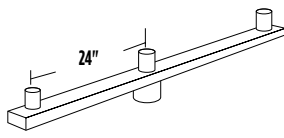

BKS-PTB-13-CLR
Part# 137106CLR

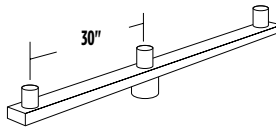

BKS-PTB-13-30-CLR
Part# 137107CLR

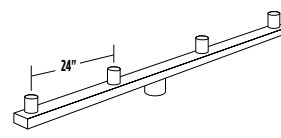

BKS-PTB-14-CLR
Part# 137108CLR

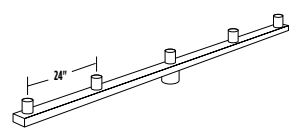

BKS-PTB-15-CLR
Part# 137109CLR

Tenon Mount Mast Arm

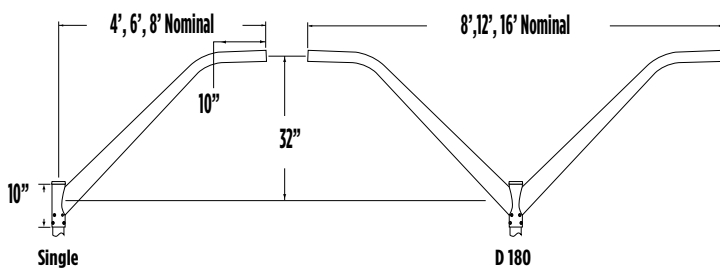

Description

- BKA PTB Mast Arm 4 S CLR
- BKA PTB Mast Arm 4 D180 CLR
- BKA PTB Mast Arm 6 S CLR
- BKA PTB Mast Arm 6 D180 CLR
- BKA PTB Mast Arm 8 S CLR

Part Numbers

- 409570CLR
- 409571CLR
- 409572CLR
- 409573CLR
- 409574CLR





Mast Arm Adaptor with 5" Traditional Drill Pattern

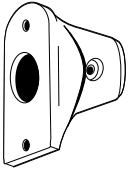

BKA NM MA 5 CLR

Mast Arm Adaptor. For use with existing mast arm by others. Cannot be used with Hilton Series. Slipfits 2" pipe [2-3/8" O.D.]

Part # 168778CLR

BKA NM MA 5 XLCL CLR

Mast Arm Adaptor For use XLCL

Part # 617865CLR

Tenon Reducers

NM-RD Steel round slipfitter reducer, comes with set screws and one through bolt.

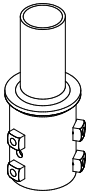

Part Number	Description	I.D.	O.D.	Fits	How Much Play
137096CLR	BKS-NM-RD-2.5-CLR	3.068"	3.5"	2.875" O.D	2-5/8" to 2-7/8"
137093CLR	BKS-NM-RD-3.0-CLR	3.640"	4.0"	3.5" O.D.	3-1/4" to 3-1/2"

NOTES:

Part description refers to pipe size. Top tenon is 2" pipe or 2-3/8" dia. x 4-3/4" high.

How Much Play = For the in between sizes of their tenon, you have about 1/4" play.

Fits = Customer's existing tenon size.

Internal Tenon Adapter Square Pole



4" SQ Pole
Part# 694638CLR

5" SQ Pole
Part# 694641CLR

6" SQ Pole
Part# 694642CLR

Internal Slip Fitter Bracket For 4" & 5" Square Poles

U.S. Patent # 5,599,094

BKA (4ISF, 5ISF) (Q90, D180) CLR for 5" traditional drill pattern

BKA (X4ISF, X5ISF) (D90, D180) CLR for 3" reduced drill pattern

Utilize to retrofit existing 4" & 5" square poles. Use with 4" & 5" SQI poles with wall thickness of 11 ga. (0.120) or 7 ga. (0.180). D180 slipfitters come with (1) set of plugs. Q90 slipfitters come with (2) sets of plugs

*Do not use on round tapered or round poles

Use with B5 drill pattern fixtures

Description	Part#
BKA 4ISF D180 * CLR	122625CLR
BKA 4ISF Q90 * CLR	122626CLR
BKA 5ISF D180 * CLR	122627CLR
BKA 5ISF Q90 * CLR	122628CLR

Use with B3 drill pattern fixtures

Description	Part#
BKA X4ISF D180 * CLR	415635CLR
BKA X4ISF Q90 * CLR	440949CLR
BKA X5ISF D180 * CLR	417508CLR
BKA X5ISF Q90 * CLR	443447CLR

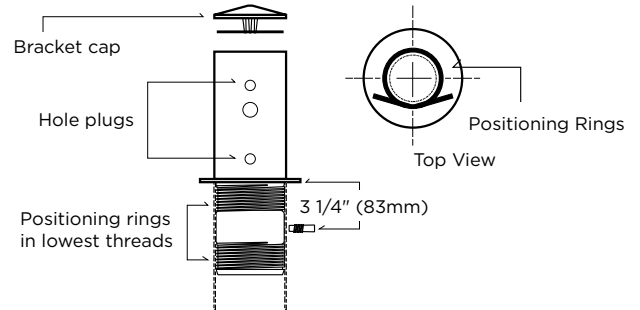

Wall and Wood Pole Brackets



BKS B0 WM CLR
Part# 123111CLR

BKS XBO WM CLR
Part# 382132CLR

BKS B2 WM CLR
Part# 698940CLR



BKS B0 B3 B5 WP CLR
Part# 751219CLR

BKS B2 WP CLR
Part# 750440CLR





Hand-Hole Cover Kits with Gasket and 2 Screws - Steel Poles Only

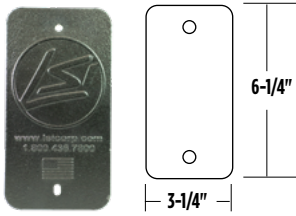

Part #349593CLR
Used on all square steel poles and all round steel poles 18'-0" and above except Round Tapered Steel.

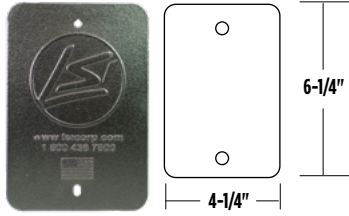

Part #547618CLR
Used on all round tapered steel poles.

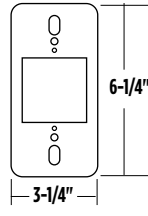

Part #53306CLR
Used on all ER2 & GFI options for all square steel poles, and all round steel poles 18'-0" and above except round tapered steel. No receptacle.

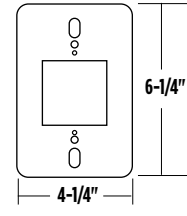

Part #53928CLR
Used on all ER2 & GFI options for round tapered steel poles. No receptacle.

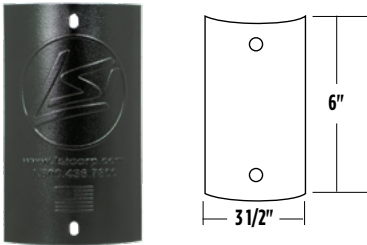

Part #141062CLR
Used on all 4" & 5" round steel poles under 18'-0"

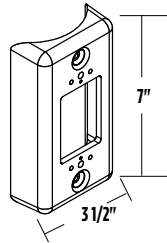

Part #5707502CLR
Used on all ER2 & GFI options for 4" & 5" round steel poles under 18' - 0". No receptacle.

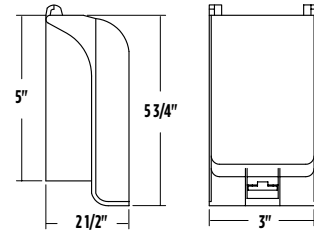

Part #179079
In use cover. Used on all ER2 & GFI options

Consult factory for aluminum pole hand-hole and GFI covers.

Pole Caps - Steel Poles Only

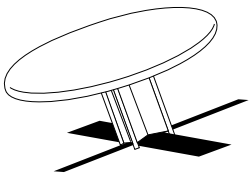

ROUND TAPERED
3" 20/25ft
Part# 639335
3-1/4" 30/50ft
Part# 639068
3-1/2" 35/39ft
Part# 639245

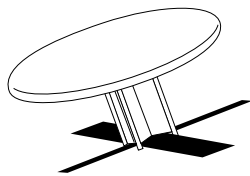

ROUND
4" **Part# 639252**
5" **Part# 639061**

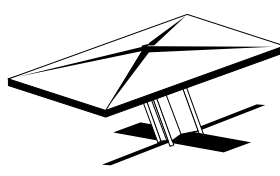

SQUARE
4" **Part# 638827**
5" **Part# 638885**
6" **Part# 639092**

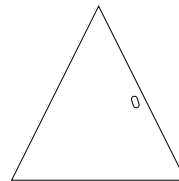

BOLT-ON TN120
for square pole
4" **Part# 639575CLR**
5" **Part# 639624CLR**

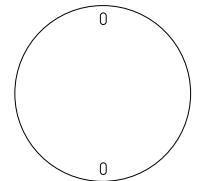

TENON FITTER
(BKA RNM)
Part# 53460CLR

Consult factory for aluminum pole caps





Base Covers

Square shaped base covers are .50 or .63 aluminum.

11.318" - 13.25" Square

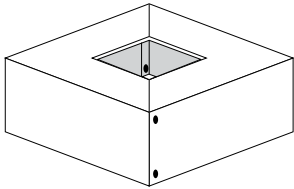

Square Steel Poles

SQ 4" BC
11.318" sq. x 4.3" tall with 4.125" sq. opening
Part# 122559CLR

SQ 5" BC
11.318" sq. x 4.8" tall with 5.125" sq. opening
Part# 122561CLR

SQ 6" BC
12.313" sq. x 5" tall with 6.125" sq. opening
Part# 122563CLR

Square Universal Replacement Poles
4" SQU
11.318" sq. x 4.3" tall with 4.125" sq. opening
Part# 122559CLR

5" SQU
12.5" sq. x 5.25" tall with 5.125" sq. opening
Part# 132488CLR

6" SQU
13.25" sq. x 5" tall with 6.125" sq. opening
Part# 131252CLR

11.318" - 13.25" Square

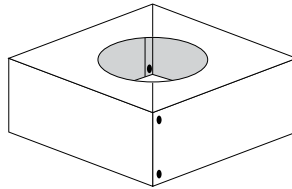

Round Steel Poles

4RP BC
4.3" tall with 4.25" dia. opening
Part# 158450CLR

5RP SRBC
4.8" tall with 5.25" dia. opening
Part# 158451CLR

Round Universal Replacement Poles

4RPU
11.318" sq. x 4.3" tall with 4.125" dia. opening
Part# 158450CLR

5RPU
13.5" sq. x 5.25" tall with 5.125" dia. opening
Part# 749059CLR

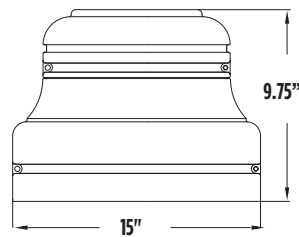

GBC 45

Decorative two-piece die cast construction fits 4" and 5" diameter straight round poles. Includes 4" round pole adaptor molded from black silicone rubber.
Part #483859CLR

11.318" - 15" Square

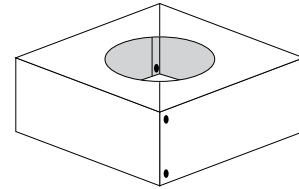

Round Tapered Steel Poles

20' SRTB
1.318" sq. x 4.8" tall with 6.15" dia. opening
Part# 158388CLR

25' SRTBC
11.318" sq. x 4.8" tall with 6.85" dia. opening
Part# 158390CLR

30' SRTBC
1.318" sq. x 4.8" tall with 7.75" dia. opening
Part# 158392CLR

35' SRTBC
13" sq. x 4.875" tall with 8.75" dia. opening
Part# 158554CLR

39' SRTBC (7 & 11 Gage)
12.875" sq. x 5.5" tall with 9.125" dia. opening
Part# 155887CLR

Round Tapered Universal Replacement Poles

20' RTPU
11.318" sq. x 4.8" tall with 6.15" dia. opening
Part# 158388CLR

25' RTPU
13" sq. x 4.875" tall with 6.81" dia. opening
Part# 162961CLR

30' RTPU
12.5" sq. x 5.25" tall with 7.75" dia. opening
Part# 497836CLR

35' RTPU
13" sq. x 4.875" tall with 8.75" dia. opening
Part# 158554CLR

39' RTPU (7 & 11 Gage)
15" sq. x 5.25" tall with 9.25" dia. opening
Part# 433035CLR





Square Aluminum Pole

Square two-piece cast base cover (optional)



4DABC - 4" Square Cast 2-Piece Base Cover
13" square x 6.31" tall
Part # 505605CLR

5DABC - 5" Square Cast 2-Piece Base Cover
13" square x 6.31" tall
Part # 505606CLR

6DABC - 6" Square Cast 2-Piece Base Cover
14.5" square x 7.25" tall
Part # 505608CLR

Round Aluminum Pole

One-piece spun aluminum collar (optional)



4RSAC
4" Round 1-Piece Spun Aluminum Collar
11.875" dia. x 5.5" tall with 4.125" opening
Part # 506859CLR

5RSAC
5" Round 1-Piece Spun Aluminum Collar
10.75" dia. x 5.5" tall with 5.125" dia. opening
Part # 506860CLR

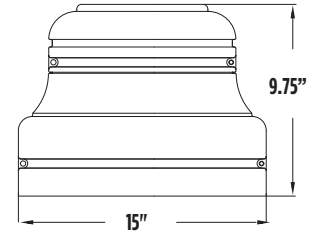

GBC 4 5
Decorative two-piece die cast construction fits 4" and 5" diameter straight round poles. Includes 4" round pole adapter molded from black silicone rubber
Part #483859CLR

Round Tapered Aluminum Pole

One-piece spun aluminum collar (optional)



5RSAC
Round 1-Piece Spun Aluminum Collar for RTP w/5" bottom
10.75" dia. x 5.5" tall with 5.125" dia. opening
Part # 505647CLR

6RSAC
Round 1-Piece Spun Aluminum Collar for RTP w/6" bottom
14" dia. x 5.5" tall with 6.125" dia. opening
Part # 505648CLR

8RSAC
Round 1-Piece Spun Aluminum Collar for RTP w/8" bottom
17.125" dia. x 5.5" tall with 8.125" dia. opening
Part # 505649CLR

Round Tapered Aluminum Pole

Aluminum two-piece cast base cover. Base cover ships with pole as a standard.



Round 2-Piece Cast Base Cover for 4" and 5" Round Hinged Base Aluminum Pole
15" dia. x 6" tall

4RHABC
Part # Consult Factory

5RHABC
Part # Consult Factory





Mounting Hole Plugs & Decal

3 sets of 3 plugs to plug unused mounting holes

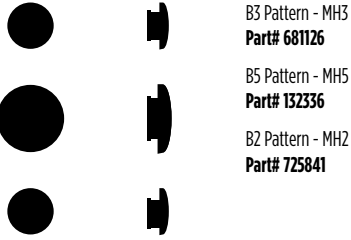

Banner Brackets

For use with straight and round poles.



Single Side Double Bracket Assembly

BBKS 4R S 18 CLR - Part# 465135CLR
 BBKS 4R S 24 CLR - Part# 407616CLR
 BBKS 4R S 30 CLR - Part# 381610CLR

BBKS 5R S 18 CLR - Part# 549406CLR
 BBKS 5R S 24 CLR - Part# 448611CLR
 BBKS 5R S 30 CLR - Part# 417702CLR

D180 Double Bracket Assembly

BBKS 4R D 18 CLR - Part# 55621010CLR
 BBKS 4R D 24 CLR - Part# 55621001CLR
 BBKS 4R D 30 CLR - Part# 55621005CLR

BBKS 5R D 18 CLR - Part# 549408CLR
 BBKS 5R D 24 CLR - Part# 55621003CLR
 BBKS 5R D 30 CLR - Part# 55621007CLR

Special EPA calculations are required on banner bracket applications, consult factory.

Vibration Damper

For use steel square poles - bolt-on mount.

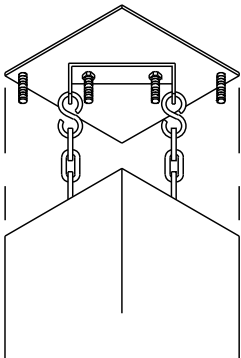

4' and 5' square pole dampers supplied with (2) 15' vinyl coated chains

6" square pole dampers supplied with (2) 20' vinyl coated chains

Poles vibration dampers are designed to reduce the amounts of vibration incurred in certain poles. They are not intended to eliminate vibration altogether. In areas where wind induced pole vibration is a risk, it is recommended to install a vibration damper when installing the pole.

Kit VIBR DMPR 4SQ Pole
 Part # 172539

Kit VIBR DMPR 5SQ Pole
 Part # 172538

Kit VIBR DMPR 6SQ Pole
 Part # 178361





3/8" X 10" Galvanized Steel

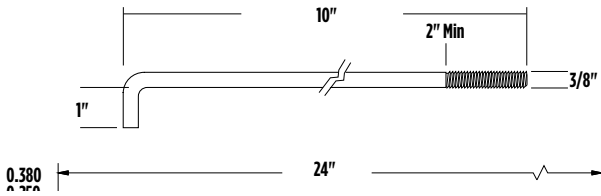

Used with:

AB kit# 285560 Bollards 4 1/2" bolt circle.

Each anchor bolt furnished with:

(2) 3/8"-16 galvanized hex nuts and (2) U.S.S. 3/8" flat washers 7/16" I.D. x 1" O.D. x 0.1" thick galvanized.

3/4" X 24" Steel / 3/4" X 24" Galvanized

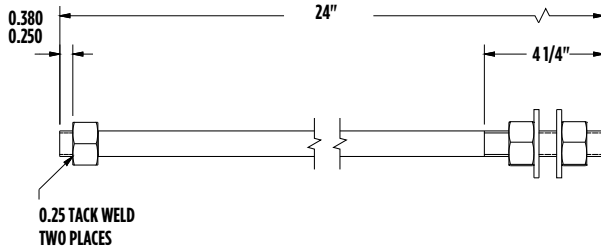

Steel used with:

AB kit# 122584	4SQ	STL	S11G/S07G	8" - 11" BOLT CIRCLE
AB kit# 122582	4RP	STL	S10G	11" BOLT CIRCLE
AB kit# 1225850	5SQ	STL	S11G	9" - 11" BOLT CIRCLE
AB kit# 135460	5RP	STL	S11G	11" BOLT CIRCLE

Galvanized used with:

AB kit# 122609	4SQ	STL	GAL S11G/S07G	11" BOLT CIRCLE
AB kit# 122607	4RP	STL	GAL S10G	11" BOLT CIRCLE
AB kit# 122610	5SQ	STL	GAL S11G	11" BOLT CIRCLE
AB kit# 135461	5RP	STL	GAL S11G	11" BOLT CIRCLE

Each anchor bolt furnished with:

(2) 3/4" - 10 zinc plated or galvanized hex nuts and (2) U.S.S. 3/4" flat washers (13/16" I.D. x 2" O.D. x 5/32" thick) zinc plated or galvanized.

1" x 30" Steel / 1" x 30" Galvanized

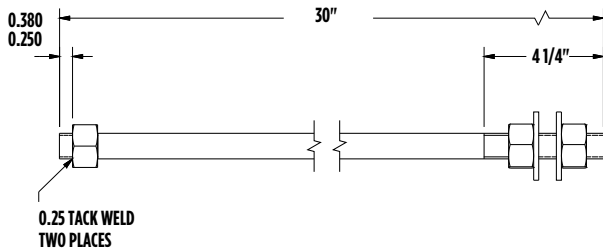

Steel used with:

AB kit# 122586	5SQ	STL	S07G	11" BOLT CIRCLE
AB kit# 122583	5RP	STL	S07G	11" BOLT CIRCLE
AB kit# 122587	6SQ	STL	S07G	12" BOLT CIRCLE
AB kit# 122588	RTP	STL	20/25/30' S11G	11" BOLT CIRCLE
AB kit# 122589	RTP	STL	35/39' S11G	12" BOLT CIRCLE

Galvanized used with:

AB kit# 122611	5SQ	STL	GAL S07G	11" BOLT CIRCLE
AB kit# 122608	5RP	STL	GAL S07G	11" BOLT CIRCLE
AB kit# 122612	6SQ	STL	GAL S07G	12" BOLT CIRCLE
AB kit# 122613	RTP	STL	GAL S11G 20/25/30'	11" BOLT CIRCLE
AB kit# 1226140	RTP	STL	GAL S11G 35/39'	12" BOLT CIRCLE

Each anchor bolt furnished with:

(2) 1" - 8 zinc plated or galvanized hex nuts and (2) U.S.S. 1" flat washers - 11/16" I.D. x 2 1/2" O.D. x 11/64" thick - zinc plated or galvanized.





1-1/4" X 42" Galvanized (Partially)

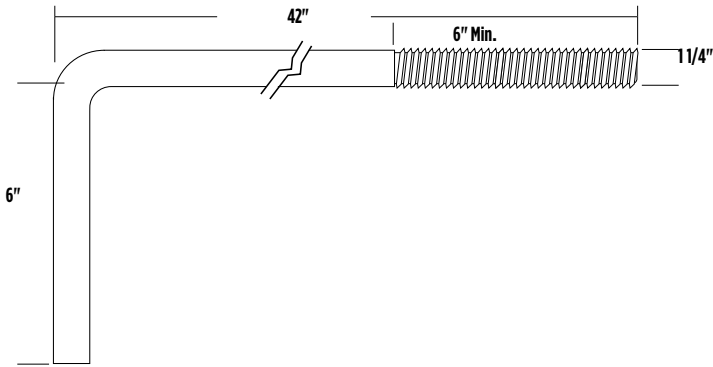

Galvanized (only) used with:

AB kit# 122615	RTP	STL	GAL 39' S07G	12" BOLT CIRCLE
AB kit# 122616	RTP	STL	GAL	14" BOLT CIRCLE

Each anchor bolt furnished with:

(2) 1 1/4" -7 galvanized hex nuts and (2) U.S.S. 1 1/4" flat washers (1 3/8" I.D. x 3" O.D. x .165" thick) galvanized.

Consult factory for aluminum pole anchor bolts.

Anchor Bolt Conversion Table

Measuring a Bolt Circle

1. Measure the distance from the center of each bolt or leading edge of each bolt. This is your **BOLT SQUARE** dimension.
2. Find the **BOLT SQUARE** dimension in the column A of the chart.
3. The number to the right in column B is your **BOLT CIRCLE**.
4. Please reference the specification sheets for standard bolt circle patterns on base plates to choose the correct pole.

"A" Bolt Square	"B" Bolt Circle
5.66"	8.00"
6.50"	9.19"
6.75"	9.50"
7.75"	11.00"
8.12"	11.5"
8.50"	12.00"
8.84"	12.50"
9.19"	13.00"
9.90"	14.00"
10.25"	14.50"
11.32"	16.00"

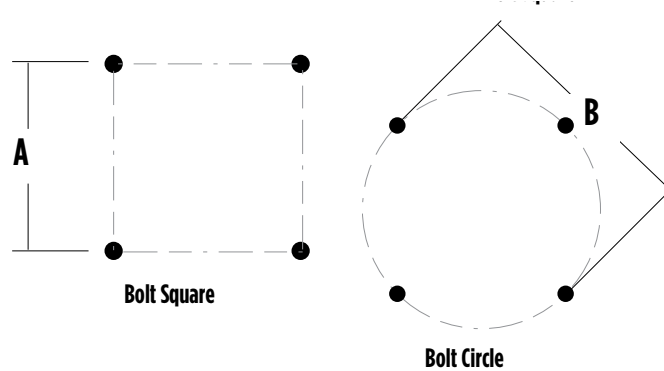

Available Pole Modifications

CUT TO LENGTH	SPECIAL BOLT CIRCLES
COUPLINGS	PAINT COLOR MATCH
SPECIAL DRILL PATTERNS	RELOCATE HAND HOLES

All modifications subject to prior engineering approval.



WIND SPEED MAP FOR ASCE 7-10

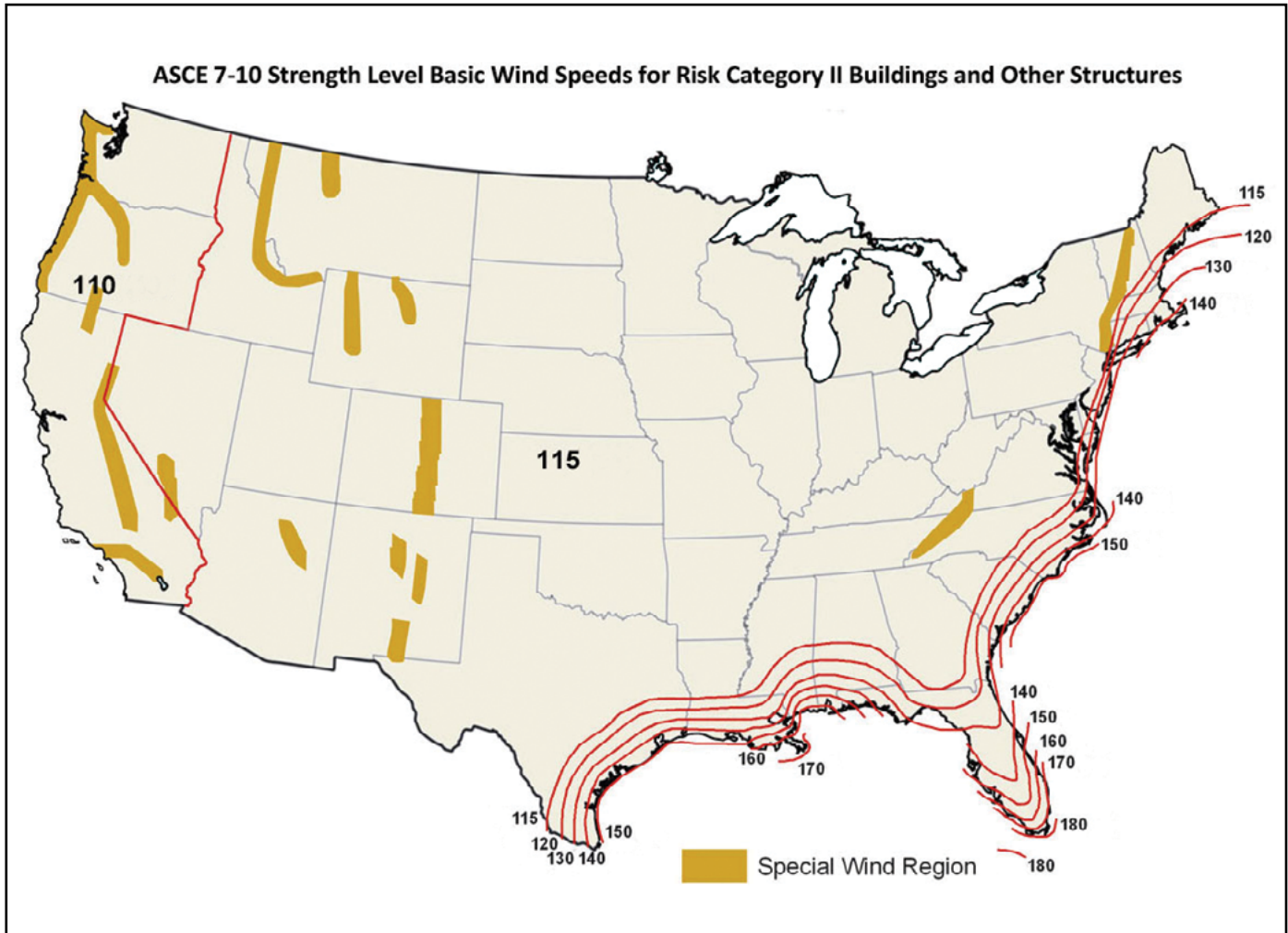

Wind Speed Map and Pole EPAs are based on ANSI/ASCE 7-10. Please inform LSI if your local code requirements differ; LSI can supply calculations to your code requirements.

NOTES:

- 1. Values are the fastest-mile speeds at 33 ft. (10 m) above ground for exposure Category 2.
- 2. Linear interpolation between wind speed contours is acceptable.
- 3. When using this map to determine EPA readings, always use high end of range.
- 4. Fixture and pole EPA values are based on wind pressures and forces specified in ANSI/ASCE 7-10.
- 5. Local code may require wind speeds other than those shown on map.

All LSI Industries' poles are guaranteed to meet the EPA requirements listed. Pole manufacturer is not responsible if a pole order has a lower EPA rating than the indicated wind-loading zone where the pole will be located. **CAUTION:** This guarantee does not apply if the pole/bracket/ fixture combination is used to support any other items such as flags, pennants, or signs, which would add stress to the pole. LSI Industries cannot accept responsibility for harm or damage caused in these situations.

For pole EPA information reference pole specification sheets.





LSI offers a full line of steel and aluminum poles and mounting accessories to complete your lighting assembly. We apply our same high-quality standards to our outdoor mounting accessories and lighting poles in square, round and round tapered shafts. Aluminum fluted and hinged base poles are also available.

Our poles are designed and engineered for durability and are protected with our oven baked DuraGrip Protection System. For unmatched corrosion resistance and an extended warranty, choose our DuraGrip+ Protection System.

Our poles are American made in our Ohio facility with industry leading lead times.

Not using an LSI fixture? LSI poles can be custom drilled to match nearly any fixture. However, when you order your entire lighting system from LSI, we guarantee a precise color match between fixture, pole and brackets.

Contact us today to learn how we can help you!

Call (513) 372-3200

Visit www.lsicorp.com

POLE
BASICS