



Hilton (HLN)

Outdoor Area Light



OVERVIEW

Lumen Package (lm)	18,000 - 32,000
Wattage Range (W)	155 - 310
Efficacy Range (LPW)	95 - 120
Weight lbs (kg)	30 (13.6)

QUICK LINKS

FEATURES & SPECIFICATIONS

Construction

- Round thick gauge spun aluminum housing and top-access cover.
- Rigid extruded aluminum bracket arm for consistency and strength.
- Precision die cast aluminum heatsink and optical frame.
- A round pole plate (RPP2) is provided as standard for mounting to 3" - 5" round poles.
- All exposed fasteners are black oxide coated stainless steel. Internal fasteners are stainless steel or zinc electroplated steel.
- Luminaire is proudly made in the U.S.
- Fixtures are finished with LSI's DuraGrip® polyester powder coat finishing process. The DuraGrip finish withstands extreme weather changes without cracking or peeling. Other standard LSI finishes available. Consult factory.
- LSI offers optional color coordinated decals in 9 standard colors to accent the fixture. Decals are guaranteed for five years against peeling, cracking, or fading. (See ordering guide for color options)
- Shipping weight: 30 lbs in carton.

Optical System

- State-of-the-Art one piece silicone optic sheet delivers industry leading optical control with an integrated gasket to provide IP66 rated sealed optical chamber in 1 component.
- Proprietary silicone refractor optics provide exceptional coverage and uniformity in IES Types 2, 3, 5W and FT.

- Silicone optical material does not yellow or crack with age and provides a typical light transmittance of 93%.
- Zero uplight.
- Available in 5000K, 4000K, and 3000K color temperatures per ANSI C78.377.
- Minimum CRI of 70
- Integral louver (IL) option available for improved backlight control without sacrificing street side performance.

Electrical

- High-performance programmable driver features over-voltage, undervoltage, short-circuit and over temperature protection. Custom lumen and wattage packages available.
- 0-10V dimming (10% - 100%) standard.
- Standard Universal Voltage (120-277 Vac) Input 50/60 Hz or optional High Voltage (347-480 Vac).
- L70 Calculated Life: >100k Hours
- Total harmonic distortion: <20%
- Operating temperature: -40°C to +50°C (-40°F to +122°F).
- Power factor: >.90
- Input power stays constant over life.
- Field replaceable surge protection device meets a minimum Category C Low operation (per ANSI/IEEE C62.41.2).
- High-efficacy LEDs mounted to metal-core circuit board to maximize heat dissipation
- Terminal block provided accepts up to 10ga wire.

- Components are fully encased in potting material for moisture resistance. Driver complies with FCC standards.

Installation

- Three stainless steel captive top-cover fasteners provide secure top cover closure and allow easy access with no loose hardware. The top cover is attached to housing via a tether clip, which frees both hands while installing/ servicing.
- Included terminal block provides quick and easy on-site wiring.
- Stainless/plated steel threaded rod, nuts, and nut plate fasten the housing securely to the pole through the extruded aluminum arm.
- Utilizes LSI's traditional B5 drill pattern for easy retrofitting of legacy LSI products.

Warranty

- LSI luminaires carry a 5-year limited warranty. Refer to <https://www.lsicorp.com/resources/terms-conditions-warranty/> for more information.

Listings

- Listed to UL 1598 and UL 8750.
- RoHS Compliant.
- Title 24 Compliant; see local ordinance for qualification information.
- Suitable for wet Locations
- IP65 rated luminaire (per IEC 60598) protects integral components from harsh environments. IP66 rated optical chamber.
- 1.5G rated for ANSI C136.31 high vibration applications.



Hilton (HLN) Outdoor Area Light

Type : _____

 **Have questions?** Call us at (800) 436-7800

ORDERING GUIDE

TYPICAL ORDER EXAMPLE: HLN 5W LED 18L 50 UE BRZ IMSBTL1								
Prefix	Distribution	Light Source	Lumen Package	Color Temperature	Voltage	Finish	Controls	Options
HLN - Hilton	2 - Type 2 3 - Type 3 FT - Type 4 Forward Throw 5W - Type 5 Wide	LED	18L - 18,000 lms 27L - 27,000 lms 32L - 32,000 lms Custom Lumen Packages ⁶	50 - 5000K 40 - 4000K 30 - 3000K	UE - Universal Voltage (120-277V) HV - High Voltage (347-480V)	BRZ - Dark Bronze BLK - Black GMG - Gun Metal Gray GPT - Graphite MSV - Metallic Silver WHT - White PLP - Platinum Plus SVG - Satin Verde Green	(Blank) - None Wireless Controls System ALBCS1 - AirLink Blue Wireless Motion & Photo Sensor Controller (8-24' MH) ALBCS2 - AirLink Blue Wireless Motion & Photo Sensor Controller (25-40' MH) Stand-Alone Controls IMSBTL1 - Integral Bluetooth™ Motion and Photocell Sensor max 8-24' mounting height ² IMSBTL2 - Integral Bluetooth™ Motion and Photocell Sensor (max 25-40' mounting height ² CR7P - 7 Pin Control Receptacle ANSI C136.41 ¹	(Blank) - None IL - Integral Louver Shield Color Decals 45 Light Gold 20 Charcoal Metallic 55 Black 94 Blue Metallic 59 Dark Green 51 Dark Red 21 Tomato Red 50 White 700 Aztec Silver Metallic



Need more information?
[Click here for our glossary](#)

Have additional questions?
Call us at (800) 436-7800



CONTROLS ORDERING INFORMATION

Part Number	Description
122514	PC120 Photocell for use with CR7P option (120V) ⁴
122515	PC208-277 Photocell for use with CR7P option (208V, 240V, 277V) ⁴
122516	Twist Lock Photocell (347V) for use with CR7P ⁴
1225180	Twist Lock Photocell (480V) for use with CR7P ⁴
61409	AirLink 5 Pin Twist Lock Controller ⁴
661410	AirLink 7 Pin Twist Lock Controller ⁴
149328	Shorting Cap for use with CR7P ⁴

FUSING ACCESSORIES⁵

Part Number	Description
See Fusing Guide	Single Fusing (120V)
	Single Fusing (277V)
	Double Fusing (208V,240V)
	Double Fusing (347V)
	Double Fusing (480V)

SHIELDING ACCESSORIES²

Part Number	Description
654939	IL - Integral Louver (Sharp Spill Light Cutoff)

1 - Control device or shorting cap must be ordered separately. See Accessory Ordering Information.
 2 - IMSBT is field configurable via the LSI app that can be downloaded from your HLNrtphone's native app store.
 3 - Accessories are shipped separately and field installed.
 4 - Factory installed CR7P option required. See Options.
 5 - Fusing must be located in hand hole of pole.
 6 - Custom lumen and wattage packages available consult factory. Values are within industry standard tolerances but not DLC listed.

Hilton (HLN) Outdoor Area Light

Type: _____

 Have questions? Call us at (800) 436-7800

PERFORMANCE

Delivered Lumens												
Lumen Package	Distribution	CRI	3000K CCT			4000K CCT			5000K CCT			Wattage
			Delivered Lumens	Efficacy	BUG Rating	Delivered Lumens	Efficacy	BUG Rating	Delivered Lumens	Efficacy	BUG Rating	
18L	2	70	16615	107	B3-U0-G3	17913	116	B3-U0-G3	17967	116	B3-U0-G3	155
	3		17247	111	B2-U0-G3	18585	120	B2-U0-G3	18641	120	B2-U0-G3	
	FT		17073	110	B3-U0-G3	18398	119	B3-U0-G3	18453	119	B3-U0-G3	
	5W		16689	108	B4-U0-G2	17984	116	B4-U0-G2	18038	116	B4-U0-G2	
27L	2	70	24086	101	B3-U2-G3	27039	114	B4-U2-G4	27119	114	B4-U2-G4	238
	3		24433	103	B3-U2-G3	27422	115	B3-U2-G4	27504	116	B3-U2-G4	
	FT		24329	102	B3-U2-G3	27305	115	B3-U2-G4	27387	115	B3-U2-G4	
	5W		23786	100	B4-U2-G2	26696	112	B4-U2-G2	26776	113	B4-U2-G2	
32L	2	70	29495	95	B4-U2-G3	32137	104	B4-U2-G3	32250	104	B4-U2-G3	310
	3		30104	97	B3-U2-G4	32793	106	B3-U2-G4	32891	106	B3-U2-G4	
	FT		30489	98	B3-U2-G4	33212	107	B3-U2-G4	33312	107	B3-U2-G4	
	5W		29484	95	B5-U2-G3	32129	104	B5-U2-G3	32225	104	B5-U2-G4	

*LEDs are frequently updated therefore values are nominal.

Electrical Data*						
Lumen Package	120V	208V	240V	277V	347V	480V
18L	1.29	0.75	0.65	0.56	0.45	0.32
27L	1.98	1.14	0.99	0.86	0.69	0.50
32L	2.58	1.49	1.29	1.12	0.89	0.65

*Electrical data at 25C (77F). Actual wattage may differ by +/-10%.

PHOTOMETRICS

Luminaire photometry has been conducted by a NVLAP accredited testing laboratory in accordance with IESNA LM-79-08. As specified by IESNA LM-79-08 the entire luminaire is tested as the source resulting in a luminaire efficiency of 100%.

See the individual product page on <https://www.lsicorp.com/> for detailed photometric data.

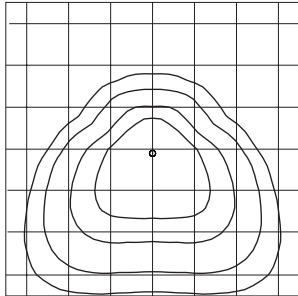

FT

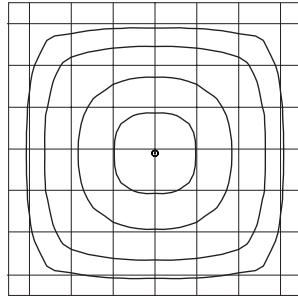

5W

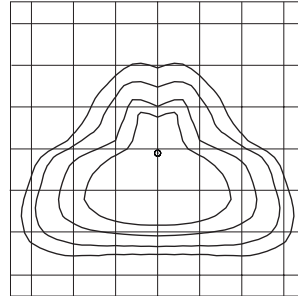

Type 3

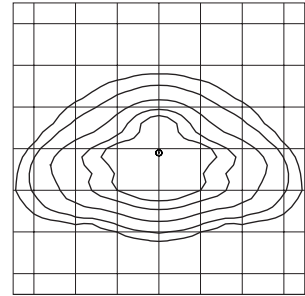

Type 2





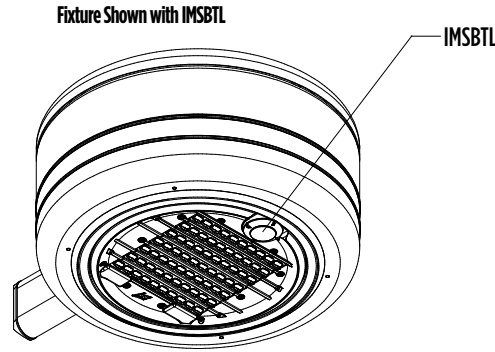
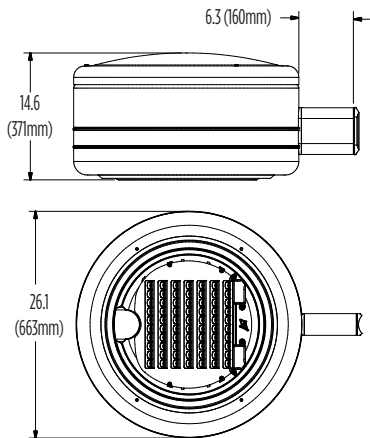

Hilton (HLN) Outdoor Area Light

Type : _____

 Have questions? Call us at (800) 436-7800

PRODUCT DIMENSIONS



LUMINAIRE EPA CHART		
	Single	1.9
	D180°	3.7
	D90°	3.3
	T90°	5.2
	TN120°	5.2
	Q90°	6.7

Mounting Detail

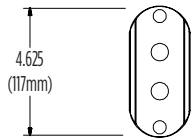

ACCESSORIES/OPTIONS

Integral Louver (IL)

Optional Integral Louver available for improved back-light control without sacrificing street side performance.

7 Pin Photoelectric Control

7-pin ANSI C136.41-2013 photocontrol receptacle option available for twist lock photocontrols or wireless control modules. Control accessories sold separately. Dimming leads from the receptacle will be connected to the driver dimming leads (Consult factory for alternate wiring).

Fixture Shown with Integral Louver (IL)

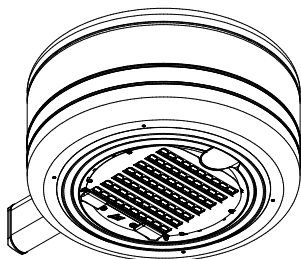

Fixture Shown with CR 7P

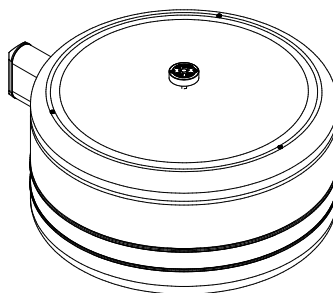

Hilton (HLN) Outdoor Area Light

Type : _____

 **Have questions?** Call us at (800) 436-7800

CONTROLS

Integral Bluetooth™ Motion and Photocell Sensor (IMSBTxL)

Slim low profile sensor provides multi-level control based on motion and/or daylight. Sensor controls 0-10 VDC LED drivers and is IP66 rated for cold and wet locations (-40°F to 167°F). Two unique PIR lenses are available and used based on fixture mounting height. All control parameters are adjustable via an iOS or Android App capable of storing and transmitting sensor profiles.

[Click here to learn more details about IMSBT](#)



LEVITON App



Apple



Android

AirLink Blue (ALBCSx)

Wireless Bluetooth Mesh Outdoor Lighting Control System that provides energy savings, code compliance and enhanced safety/security for parking lots and parking garages. Three key components; Bluetooth wireless radio/sensor controller, Time Keeper and an iOS App. Capable of grouping multiple fixtures and sensors as well as scheduling time-based events by zone. Radio/Sensor Controller is factory integrated into Area/Site, Wall Mounted, Parking Garage and Canopy luminaires.

[Click here to learn more details about AirLink Blue](#)



AirLink Blue App



Apple

Sensor Sequence of Operations

Standard Programming	On Event	Off Event	On Light Level	Dim Light Level	Daylight Harvesting	Delay To Off	Sensitivity
OMSBTxL/IMSBTxL	Motion	No Motion	100%	N/A	On; Auto Calibration	20 minutes	High
OMS	Motion	No Motion	N/A	N/A	N/A	30 seconds	Auto

Operation	Description
On Event	Trigger that activates lights to turn on; either automatic via motion detected or manually activated via push of button.
Off Event	Trigger that activates lights to turn off; either automatic via no motion detected or manually activated via push of button.
On Light Level	The light level that the fixtures will turn on to when ON EVENT occurs.
Dim Light Level	The light level that the fixtures will dim down to when no motion is detected.
Delay to Dim	The amount of time after which no motion is detected that the fixtures will be triggered to dim down. This sequence is optional, and sensor can be programmed to only trigger the fixture to turn off by entering 100% in this field.
Delay to Off	The amount of time after which no motion is detected that the fixtures will be triggered to turn off. If delay to dim is part of the programmed functionality, this is the amount of time after which no motion is detected after the fixture have already dimmed down.
Sensitivity	The sensitivity can be set to high, medium, low, or auto where applicable. High will detect smaller, simple motions. Low will only detect larger more complex motions. Auto temperature calibration adjusts the PIR sensitivity as ambient temperature rises to increase detection of heat movement through the field of view.