

Catalog # :

Project :

Prepared By :

Date :



LCD8 8" LED Commercial Downlight



8 inch LED new construction downlight delivers superior performance and energy efficiency. Designed to use anodized aluminum reflectors delivering even illumination and low glare. The high performance luminaire offers 1000 up to 4000 lumens with color temperatures of 2700K, 3000K, 3500K, 4000K at 80 CRI. Standard driver offers universal (120-277V) and 0 -10V dimming down to 1%. The LCD series is ideal for low to medium ceiling heights for retail, hospitality and commercial applications.



Features & Specifications

Optical System

- LED source provides superior lumen output with maximum visual comfort.
- Tailored spot, narrow flood, flood and wide flood beam optics designed for glare free illumination.
- Choice of flanged or flangeless spun reflector utilizing heavy gauge highly reflective diffuse anodized aluminum to deliver low glare, even illumination of the space.
- Reflectors are retained with three retention clips holding the flange tight to the finished ceiling surface.
- Minimum CRI of 80.

Electrical

- High-performance driver features over-voltage, under voltage, short-circuit and over temperature protection.
- 0-10 volt dimming (1% - 100%) standard.
- Standard Universal Voltage (120-277 Vac) Input 50/60 Hz.
- L70 Calculated Life: > 50k Hours projected @ 25°C per IESNA TM-21-11.
- Total harmonic distortion: <20%
- Power factor: >.90
- Input power stays constant over life.
- Compatible with Triac (forward-phase or leading-edge), ELV (reverse-phase or trailing edge) dimming only at 120 Vac.
- Driver can be accessed from below plenum for servicing.
- High-efficacy LEDs with integrated circuit board mount directly to an extruded aluminum heatsink to maximize heat dissipation and promote long life.
- Remote Emergency Battery (120-277V) field installed is available to meet critical life safety lighting requirements. The 90-minute battery provides 7.8watts constant power to the LED system, ensuring code compliance. To calculate light output during emergency mode(EM battery 7.8 watts x LPW of fixture being powered - see spec sheet). Detailed wiring diagram and installation instructions located on website.



Dimensions

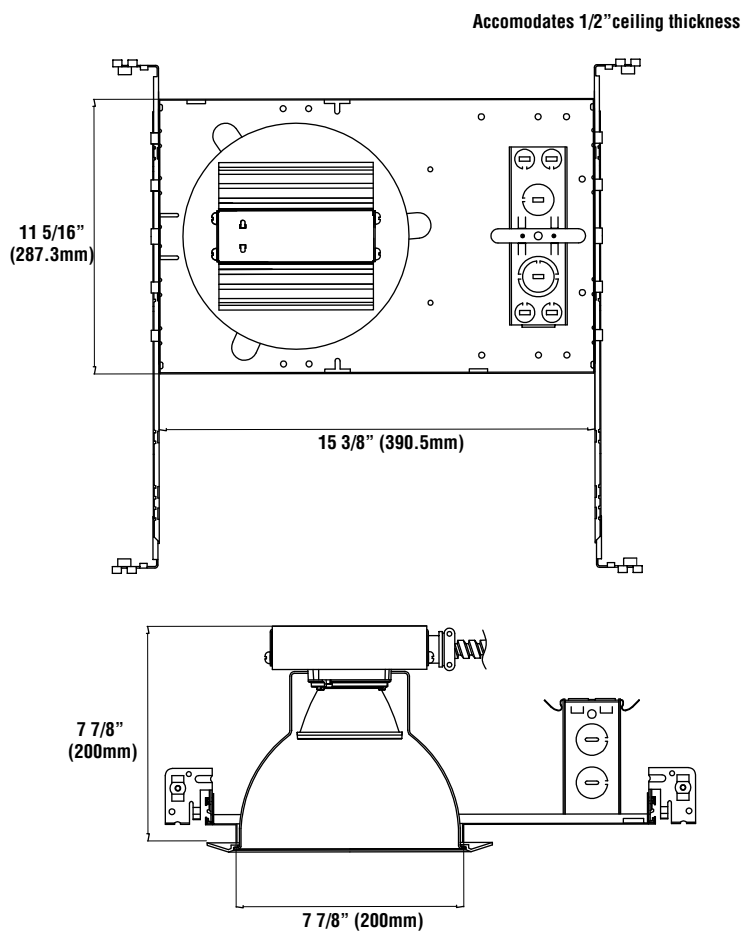



Features & Specifications (cont.)

New Construction Housing/Plaster Frame

- Designed for use in non-insulated ceiling where insulation must be kept a minimum of 3" from the fixture.
- Junction box listed for (8) #12 AWG (four in, four out) 90°C conductors and thru branch wiring.
- Junction box contains (5) 1/2" knockouts with trade pry-out slots and (4) Romex cable clamp knockouts.
- Frame accomodates up to 1/2" ceiling thickness. Standard 24" nailer bars ship with each unit and field installed.

Installation

- 24" nailer bars provide stability and support for installation on joists, T-Grid and suspended ceilings.
- Housings can be positioned at any point within the 24" joist span.
- Score lines allow adjustments for 12" joists without tools.

Warranty

- LSI LED Fixtures carry a 5-year warranty.
- 1 Year warranty on optional Emergency Battery. Test regularly in accordance with local codes.

Listing

- cETLus Listed to UL 1598 and UL 8750 standards for 25°C Ambient applications
- RoHS Compliant.
- EMI/RFI compliant with FCC 47CFR Part 15 Class B Consumer limits and Class A Commercial & Industrial.
- Damp location rated
- Title 24 Compliant.

Performance

Electrical Data (Amps)*				
Lumen Package	120V	208V	240V	277V
14L	0.12	0.07	0.06	0.05
25L	0.18	0.11	0.09	0.08
33L	0.27	0.15	0.13	0.12
42L	0.35	0.20	0.18	0.15

*Electrical Data at 25C (77F)/ Actual Wattage may differ +/-10%

DELIVERED LUMENS*										
Lumen Pkg.	Distribution	2700K CCT		3000K CCT		3500K CCT		4000K CCT		Wattage
		Delivered Lumens	Efficacy	Delivered Lumens	Efficacy	Delivered Lumens	Efficacy	Delivered Lumens	Efficacy	
14L	SP	1213	88.6	1213	86.6	1489	106.4	1489	106.4	14
	NF	1192	85.1	1192	95.1	1463	104.5	1463	104.5	14
	FL	1181	84.4	1181	84.4	1450	103.6	1450	103.6	14
	WF	1121	80.1	1121	80.1	1376	98.3	1376	98.3	14
25L	SP	2099	95.4	2099	95.4	2576	117.1	2576	117.1	22
	NF	2063	93.8	2063	93.8	2531	115.0	2531	115.0	22
	FL	2044	92.9	2044	92.9	2508	114.0	2508	114.0	22
	WF	1940	88.2	1940	88.2	2380	108.2	2380	108.2	22
33L	SP	2750	85.9	2750	85.9	3375	105.5	3375	105.5	32
	NF	2702	84.4	2702	84.4	3316	103.6	3316	103.6	32
	FL	2678	83.7	2678	83.7	3285	102.7	3285	102.7	32
	WF	2541	79.4	2541	79.4	3118	97.4	3118	97.4	32
42L	SP	3527	84.0	3527	84.0	4328	103.0	4328	103.0	42
	NF	3465	82.5	3465	82.5	4252	101.2	4252	101.2	42
	FL	3434	81.8	3434	81.8	4213	100.3	4213	100.3	42
	WF	3259	77.6	3259	77.6	3998	95.2	3998	95.2	42

*LED Chips are frequently updated therefore values may change. Data is based on Haze Reflector.



LCD8 8" LED Commercial Downlight

Luminaire Ordering Guide

TYPICAL ORDER EXAMPLE: **LCD8 LED 25L UNV DIM1 35 NF TR8R HAZ**

Family/ Size	LED Gen	Lumen Package	Voltage	Driver	Color Temperature	CRI	Beam Optics ⁶
LCD8 - 8" New Construction ⁴	LED	14L - 1400 25L - 2500 33L - 3300 42L - 4200	UNV - 120-277V	DIM1 - Dims to 1% (0-10V dimming)	30 - 3000K 35 - 3500K 40 - 4000K	Blank - 80 CRI	SP - Spot NF - Narrow Flood FL - Flood WF - Wide Flood

	Reflector	Finish
Self-Flange	TR8R - Open Reflector	SF HAZ - Haze semi- diffused SF SPC - Specular clear
	TR8RWW - Wall Wash ²	SF HAZ - Haze semi-diffused
Flangeless (ship standard w/ white plastic trim ring)	TR8R - Open Reflector	HAZ - Haze semi-diffused, white trim ring SPC - Specular clear, white trim ring
	TR8RFL - Frosted Floating Lens ³	HAZ - Haze semi-diffused Reflector w/ Frosted Floating Lens, w/ integrated white metal trim ring (optional trim ring not compatible) SPC - Specular Clear Reflector w/ Frosted Floating Lens, w/ integrated white metal trim ring (optional ring not compatible)
	TR8RWW - Wall Wash ²	HAZ - Haze semi-diffused wall wash reflector, white trim ring
	TR8B - Baffle	HAZ - Haze semi-diffused reflector WH - White baffle and white trim ring BL - Black Baffle and white trim ring
	TR8BL - Baffle w/ Regressed Lens ¹	HAZ - Hazed semi-diffused WH - White baffle and white trim ring SPC - Specular clear BL - Black baffle and white trim ring
	TR8RL - Regressed Lens ¹	HAZ - Haze semi-diffused reflector w/ specular clear regressed lens and white trim ring SPC - Specular clear reflector w/ specular clear regressed lens and white trim ring

Accessory Ordering Information (Accessories are field installed)

Description	Order Number
WH - White metal trim ring (only compatible w/flangeless trims)	616107
EM - Emergency Battery	658633

NOTES:

1. Regressed lens trims are wet location listed. All other trims are rated for damp location.
2. TR8RWW wall wash reflector comes with 40° integrated optic; additional beam optics not compatible
3. TR8RFL frosted floating lens comes with integrated white metal trim; accessory white metal trim ring not required)
4. Housing can ship ahead of the light engine and reflector
5. 90 CRI requires 55 day leadtime & 100 MOQ; Consult Factory
6. Refer to IES File for Beam Spread.



Photometry

LCD8-LED-25L-35-SP-TR8R-SF-HAZ

Lumens: 2,576
Watts: 22.4
Efficacy: 115

Candela Power Distribution

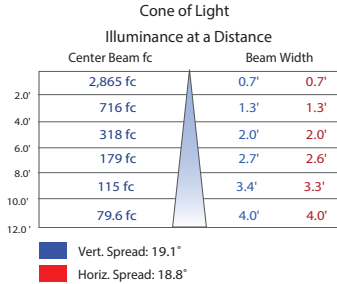
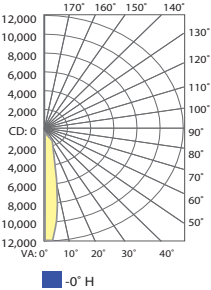

ZONE	LUMENS	% Fixture
0-10	781	30.3%
10-20	772	30.0%
20-30	588	22.8%
30-40	388	15.1%
40-50	40	1.5%
50-60	6	0.2%
60-70	1	0.0%
70-80	1	0.0%
80-90	0	0.0%
90-100	0	0.0%
0-180	2,576	100.0%

Degree Vertical	Candela
0	11,459
5	9,884
10	5,312
15	2,573
20	1,647
25	1,272
30	1,023
35	700
40	146
45	37
50	15
55	5
60	2
65	1
70	1
75	1
80	0
85	0
90	0

LCD8-LED-25L-35-NF-TR8R-SF-HAZ

Lumens: 2,531
Watts: 22.4
Efficacy: 113

Candela Power Distribution

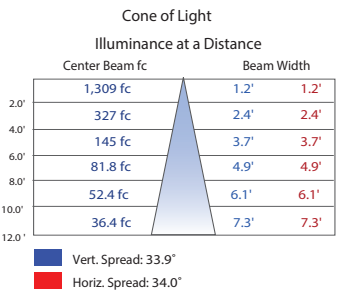
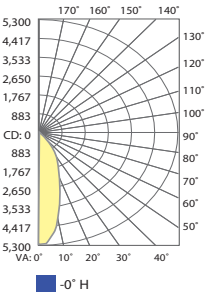

ZONE	LUMENS	% Fixture
0-10	445	17.6%
10-20	830	32.8%
20-30	733	29.0%
30-40	454	17.9%
40-50	60	2.4%
50-60	7	0.3%
60-70	1	0.0%
70-80	1	0.0%
80-90	0	0.0%
90-100	0	0.0%
0-180	2,531	100.0%

Degree Vertical	Candela
0	5,235
5	5,002
10	4,057
15	2,968
20	2,127
25	1,565
30	1,189
35	821
40	203
45	63
50	23
55	5
60	1
65	1
70	1
75	0
80	0
85	0
90	0

LCD8-LED-25L-35-FL-TR8R-SF-HAZ

Lumens: 2,509
Watts: 22.4
Efficacy: 112

Candela Power Distribution

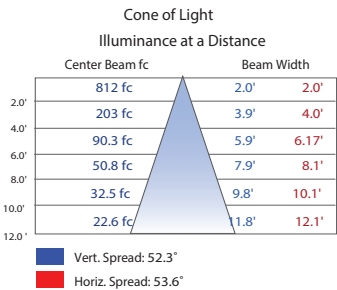
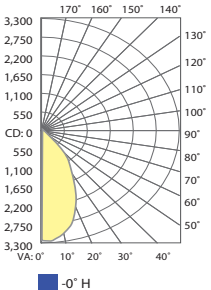

ZONE	LUMENS	% Fixture
0-10	302	12.60%
10-20	764	30.5%
20-30	820	32.7%
30-40	520	20.7%
40-50	90	3.6%
50-60	10	0.4%
60-70	1	0.1%
70-80	1	0.0%
80-90	0	0.0%
90-100	0	0.0%
0-180	2,509	100.0%

Degree Vertical	Candela
0	3,249
5	3,216
10	3,034
15	2,713
20	2,249
25	1,729
30	1,319
35	920
40	271
45	104
50	38
55	7
60	2
65	1
70	1
75	1
80	0
85	0
90	0



Photometry (cont.)

LCD8-LED-25L-35-WF-TR8R-SF-HAZ

Lumens: 2,380
Watts: 22.4
Efficacy: 106

Candela Power Distribution

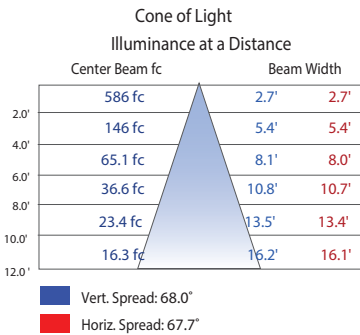
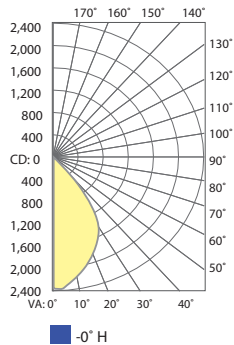

ZONE	LUMENS	% Fixture
0-10	216	9.05%
10-20	557	23.38%
20-30	746	31.33%
30-40	629	26.42%
40-50	199	8.34%
50-60	29	1.23%
60-70	4	0.15%
70-80	2	0.07%
80-90	0	0.02%
90-100	0	0.0%
0-180	2,380	100.0%

Candela Table	
Degree Vertical	Candela
0	2,343
5	2,316
10	2,164
15	1,983
20	1,817
25	1,632
30	1,422
35	1,102
40	475
45	242
50	100
55	21
60	5
65	3
70	2
75	2
80	1
85	0
90	0

8" Recessed Downlight Reflectors



TR8R - Open Reflector
Self-Flange or Flangeless
HAZ - Haze semi-diffused
SPC - Specular clear



TR8RFL - Frosted floating lens
Flangeless
HAZ - Haze semi-diffused
SPC - Specular clear
Integrated white metal trim ring



TR8BL - Baffle w/ regressed lens
Flangeless
HAZ - Haze semi-diffused
SPC - Specular clear
Choice of white or black baffle
Wet Location listed



TR8RWW - Wall wash w/ Kick reflector
Self-Flange or Flangeless
HAZ - Haze semi-diffused



TR8B - Baffle
Flangeless
HAZ - Haze semi-diffused reflector
Choice of white or black baffle



TR8RL - Regressed lens w/specular clear reflector
Flangeless
HAZ - Haze semi-diffused
SPC - Specular clear
Wet Location Listed