

LED CANOPY LIGHT - LEGACY™ (CRU)

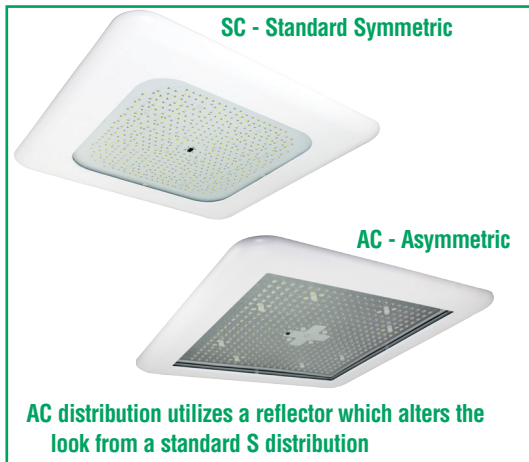

DOE LIGHTING FACTS

Department of Energy has verified representative product test data and results in accordance with its Lighting Facts Program. Visit www.lightingfacts.com for specific catalog strings.

US & Int'l. patents pending.

HOUSING - Low profile, durable die-cast, aluminum construction, providing a reliable weather-tight seal.

LEDS - Select, mid-power, high brightness, LED chips; Cool White 5000K color temperature, 70 CRI (nominal).

DRIVE CURRENT - Choice of High Output (HO) or Very High Output (VHO).

OPTICS / DISTRIBUTION - Choice of Symmetrical or Asymmetrical, which directs light through a clear tempered glass lens, to provide a uniform distribution of light to vertical and horizontal surfaces.

OPTICAL UNIT - Features an ultra-slim 3/4" profile die cast housing, with a flat glass lens. Unit is water-resistant, sealed to an IP67 rating. Integral designed heat sink does not trap dirt and grime, ensuring cool running performance over the life of the fixture.

PRESSURE STABILIZING VENT - Luminaire assembly incorporates a pressure stabilizing vent breather to prevent seal fatigue and failure.

HAZARDOUS LOCATION - Designed for lighter than air fuel applications. Product is suitable for Class 1 Division 2 only when properly installed per LSI installation instructions.

DRIVER - State-of-the-art driver technology superior energy-efficiency and optimum light output. LSI driver components are fully encased in potting for IP65 moisture resistance. Complies with IEC and FCC standards. Surge protected at 10KV. 0-10 V dimming supplied standard with all drive currents.

DRIVER HOUSING - Die cast aluminum, wet location rated driver/electrical enclosure is elevated above canopy deck to prevent water entry, provide easy "knock-out" connection of primary wiring and contributes to attaining the lowest operating temperatures available. Seals to optical housing via one-piece molded silicone gasket.

OPERATING TEMPERATURE - -40°C to 50°C (-40°F to +122°F)

ELECTRICAL - Universal voltage power supply, 120-277 VAC, 50/60 HZ input. LSI drivers feature two-stage surge protection (including separate surge protection built into electronic driver) meets IEEE C62.41.2-2002, Scenario 1, Location Category C.

FINISH - Standard color is white and is finished with LSI's DuraGrip polyester powder coat process. DuraGrip withstands extreme weather changes without cracking or peeling.

INSTALLATION - One person installation. No additional sealant required. Installs in a 12" or 16" deck pan. Deck penetration consists of a 4" hole, simplifying installation and water sealing. Unit is designed to quickly retrofit into existing Scottsdale (4") hole as well as openings for Encore and Encore Top Access and to reconnect wiring for the SC/ECTA without having to relocate the conduit. Retro panels are available for existing Encores (see back page) as well as kits for recessed and 2x2 installations (see separate spec sheets). Support brackets are provided standard, to prevent sagging of deck.

SHIPPING WEIGHT - 25 pounds (single pack), 50 pounds (double pack).

EXPECTED LIFE - Minimum 60,000 to 100,000 hours depending upon the ambient temperature of the installation location. See LSI web site for specific guidance.

WARRANTY - Limited 5-year warranty.

LISTING - UL and ETL listed to UL 1598, UL 8750 and other U.S. and International safety standards. Suitable for wet locations.

PHOTOMETRICS - Applications layouts are available upon request. Contact LSI Petroleum Lighting or petroleum.apps@lsi-industries.com

Class 1, Division 2 – Standard on HO only

T5 Temperature Classification – The surface temperature of this product will not rise above 100°C., within a 40°C ambient.

Gas Groups A,B,C, and D – Group A: Acetylene / Group B: Hydrogen / Group C: Propane and Ethylene / Group D: Benzene, Butane, Methane & Propane.

This product, or selected versions of this product, meet the standards listed below. Please consult factory for your specific requirements.



IP67



Project Name _____ Fixture Type _____

Catalog # _____

04/29/16

© 2016
LSI INDUSTRIES INC.

LED CANOPY LIGHT - LEGACY™ (CRU)

LUMINAIRE ORDERING INFORMATION

TYPICAL ORDER EXAMPLE: **CRU SC LED HO CW UE WHT**

Prefix	Distribution ¹	Light Source	Drive Current	Color Temperature	Input Voltage	Finish	Options
CRU	SC - Standard Symmetric AC - Asymmetric	LED	HO - High Output VHO - Very High Output	CW - Cool White (5000K)	UE - Universal Voltage (120-277V) 347-480V ²	WHT - White BRZ - Bronze BLK - Black	2L - Bi-Level Switching ³

FOOTNOTES:

- 1- AC distribution utilizes a reflector which alters the look from a standard S distribution.
- 2- 347V only available in HO drive current.
- 3- Bi-Level available on "HO" drive current only. It provides a manually operated, 2 position toggle switch to permit switching from "HO" (high) to 50% of power (low) drive currents.

ACCESSORY ORDERING INFORMATION (Accessories are field installed)

Description	Order Number	Description	Order Number
Retrofit Panels - EC / ECTA / SCF to CRU, for 16" Deck Panel	525946	Kit - Hole Plugs and Silicone (enough for 25 retrofits) ¹	1320540
Retrofit Panels - ECTA / SCF to CRU, for 12" Deck Panel	530281	CRU FKL - Flange Kit ²	537530WHT
Retrofit 2x2 Cover Panel Blank (no holes)	357282	1- Consists of (25) 7/8" hole plugs and (1) 10.3 oz tube of RTV	
Retrofit RIC Cover Panel Blank (no holes)	354702	2- Flange Kit used to mount CRU in double deck applications	

DIMENSIONS

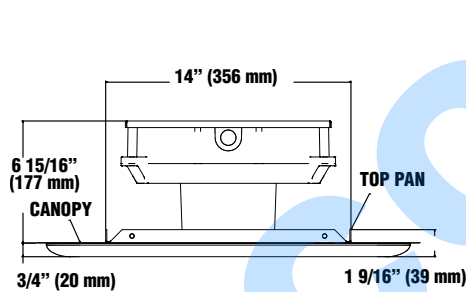
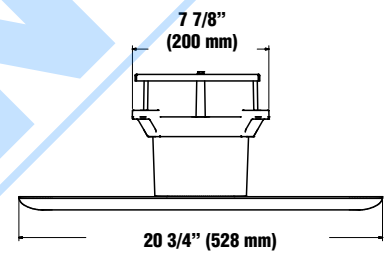
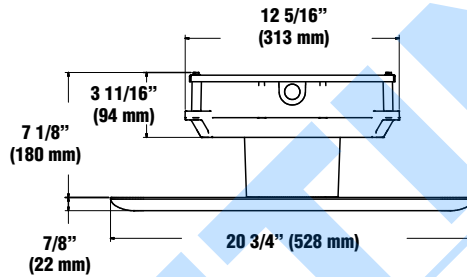
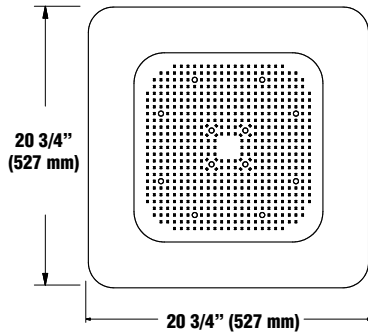

Retrofit Panels Installed

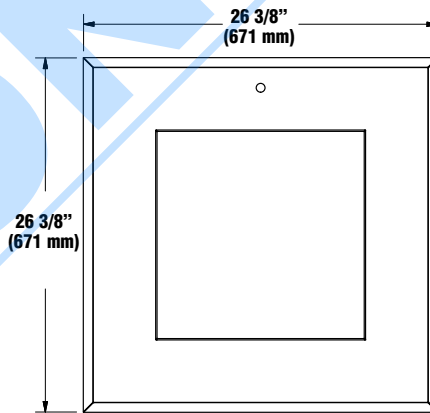

CRU FKL (for double deck applications)

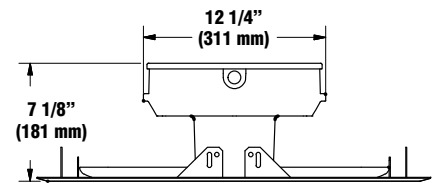

LIGHT OUTPUT - CRU

		Lumens	Watts	LPW
		SC	SC	SC
Cool White	HO - High Output	18,000	140	129
	VHO - Very High Output	21,900	164	134

