



Peak Series High Bay (PSHB)

Industrial



OVERVIEW

Lumen Package (lm)	12,000 - 72,000
Wattage Range (W)	68 - 405
Efficacy Range (LPW)	177 - 189
Weight lbs (kg)	9.6 - 27.8 (4.3 - 12.6)
Control Options	OMSx, IMSBTxL, ALBC(S), ALSC(S)

QUICK LINKS

FEATURES & SPECIFICATIONS

Construction

- Rigid housing is die-formed steel.
- All metal parts are painted after fabrication following treatment with phosphate rust inhibitor. Finish coating of housing reflecting surfaces is with high-reflectance (minimum 92%) polyester powder.
- Standard finish is gloss white. Custom color available as special request.
- Quick wire access panel allows for easy power connections.
- Manufactured in the USA.

Optical System

- Available with clear or diffuse flat acrylic lens, clear or diffuse curved acrylic lens, or without lens for maximum light output.
- For protection in high impact environments, there is an optional clear or diffuse flat polycarbonate lens available.
- Optional narrow optic available for optimal aisle distributional
- All LED boards are rotatable in 30 degree increments from 0 (direct downlight) to 180 (complete uplight) for maximum versatility in the illuminated space (see product dimensions section for details).
- Available in 3500K, 4000K, 5000K CCT. Contact factory for other CCT options.
- Minimum CRI of 80.

Electrical

- Standard Universal Voltage (120-277 VAC) Input 50/60Hz or optional High Voltage (347-480 VAC).
- L70 Calculated Life: 100,000+ hours.

- High Efficiency Driver: minimum 85%.
- 0-10V dimming (1% - 100%) standard.
- Optional 120V-480V external emergency battery pack is available to meet critical life safety lighting requirements. The 90-minute batteries provide constant power to the LED system, ensuring code compliance. A test switch/indicator button is installed on the housing for ease of maintenance.
- Emergency battery backup available up to 30W output (see EM lumen output table for details).
- Operating temperature range -40 to +60C (-40F to +141F) refer to ambient temperature table for specific units.
- Standard 6kV surge protection
 - 10kV surge protection optional.
 - All surge protection devices meet minimum Category C Low operation (per ANSI/IEEE C62.41.2).

Controls

- Controls Options Include:
 - Simple Sensor PIR end mount motion sensor available (OMSx).
 - Basic Bluetooth integral passive infrared sensor (IMSBTxL) with bluetooth app available.
 - Airlink Blue integral controller (ALBC) or integral controller with motion & photo sensor (ALBCSx).
 - LSI's AirLink Synapse wireless control system options reduce energy and maintenance costs. To order select ALSC or ALSCS (see ordering guide) as the controls option.

Installation

- Mounting options include: hook cable mount (MCH), toggle cable mount (TCH - see application note below), pendant mount (PMK) or surface mount (SMK). See accessory table for appropriate mounting hardware ordering information.
 - For EM applications, it is highly recommended to choose the TCH cable mount option to allow for side-to-side adjustment when countering the weight of the external battery (EM/EMHV).
- To maintain ambient rating, installation height can not be lower than 12'.

Warranty

- LSI luminaires carry a 5-year limited warranty. Refer to <https://www.lsicorp.com/resources/terms-conditions-warranty/> for more information.

Listings

- Listed to UL 1598 and UL 8750.
- Meets Buy American Act requirements.
- Title 24 Compliant; see local ordinance for qualification information.
- Suitable for damp locations.
- IK10 rated with polycarbonate lenses per IEC 66262 mechanical impact code.
- DesignLights Consortium® (DLC) qualified product. Not all versions of this product may be DLC qualified. Please check the DLC Qualified Products List at www.designlights.org/QPL to confirm which versions are qualified.
- Specifications and dimensions subject to change without notice.

Peak Series High Bay (PSHB) Industrial

Type : _____

 **Have questions? Call us at (800) 436-7800**

ORDERING GUIDE

TYPICAL ORDER EXAMPLE: PSHB 2 24L FAC D UNV 840 OMS2 EM SP1

Prefix	Length	Lumen Package	Lens/Distribution	Optical Presets	Voltage	Color Rendering/Temperature	Finish
PSHB - Peak Series High Bay	2 - 2ft 4 - 4ft	2 Foot 12L - 12,000 Lumens (2 row) 15L - 15,000 Lumens (2 row) 18L - 18,000 Lumens (2 row) 24L - 24,000 Lumens (4 row) 30L - 30,000 Lumens (4 row) 36L - 36,000 Lumens (4 row) 4 Foot 30L - 30,000 Lumens (2 row) 36L - 36,000 Lumens (2 row) 48L - 48,000 Lumens ¹ (4 row) 60L - 60,000 Lumens ¹ (4 row) 72L - 72,000 Lumens ¹ (4 row) <small>Custom Lumens packages available, please consult factory. Values are within industry standard tolerances and not DLC listed.</small>	LL - Less Lens ² FAC - Flat Acrylic Clear General Distribution FAD - Flat Acrylic Diffuse General Distribution FPC - Flat Polycarbonate Clear General Distribution FPD - Flat Polycarbonate Diffuse General Distribution NAC - Narrow Acrylic Clear Distribution (Aisle) CAC - Curved Acrylic Clear General Distribution CAD - Curved Acrylic Diffuse General Distribution	D - 0 Degrees - Downlight (Standard) 3 - 30 Degrees - Wide ³ 6 - 60 Degrees - Extra Wide ³ 9 - 90 Degrees - Side Light ³ I - 180 Degrees - Indirect (100% Uplight) ² <small>*Each optic row is rotatable in 30 degree increments. **120, 150 degree presets available as special order. Contact factory for all other customized factory presets ***For 3, 6, or 9 presets, only the outside rows are factory set</small>	UNV - 120V-277V HV - 347V- 480V	835 - 80CRI/3500K 840 - 80CRI/4000K 850 - 80CRI/5000K	GWT - Gloss White BLK - Black MSV - Metallic Silver

Controls	EM Options	Options
ALSC² - Airlink Synapse Control ALSCS02⁵ - Airlink Synapse Control System with 12-20' Motion Sensor ALSCS04⁵ - Airlink Synapse Control System with 20-40' Motion Sensor ALBC - AirLink Blue Controller ALBCS2 - AirLink Blue Wireless Motion & Photo Sensor Controller (25-40' mounting height) IMSBT2L - Integral Bluetooth PIR Motion And Photo Sensor up to 40' OMS2 - External PIR Sensor up to 40' OMS2-480 - External PIR Sensor up to 40' for 480V applications <small>*For low mounting height below 20ft, substitute "2" in nomenclature with "1" **For programming, please see "Sensors Sequence of Operations Charts"</small>	EM - Externally Side-Mounted Battery Backup (Wattage Varies By Lumen Package) ⁴ EMHV - Externally Side-Mounted 30W HV Battery Backup for Maximum Egress Lumens <small>*Refer EM lumen output table for light output **For cable mount applications with EM, it is recommended to use the TCH10 toggle kit to balance the fixture horizontally</small>	Standard - 6" Dimming-Capable 5 Wire Leads EXT - Extended Leads (36" Dimming-Capable 5 Wire Leads) on END CLDS - Center Leads (36" Dimming-Capable 5 Wire Leads) on CENTER X6CN - 6ft cord 16/3 non-dimming; no plug X6CD - 6ft cord 16/5 dimming; no plug X10CN - 10ft cord 16/3 non-dimming; no plug X10CD - 10ft cord 16/5 dimming; no plug X needs to be either "E" or "C" <small>*If Direct Mount - X can only be "E" (Side Mount) If Pendant or Suspended Mount - X can either be "E" (Side Mount) or "C" (Back Mount)</small> To add a plug to a cord, include the catalog string for the plug after the cord. Plugs can only be used on non-dimming cords



Need more information?
[Click here for our glossary](#)

Have additional questions?
Call us at (800) 436-7800



ACCESSORY ORDERING INFORMATION

Part Number	Order Number	Description
572488	SHC	Single Hub Chain Mount
783379R4C	MCH10	10' Mini Hook Cable Hanger (2 per) - Up/Down adjustable and Left/Right adjustable
431373	TCH10	10' Toggle Hanger (2 Per) - Up/Down and Left/Right adjustable
767710	ACH	Single Hub/Aircraft Cable Mount
813349	PSHB/ZCL PMK	Pendant Mount J-Box Kit
813352	PSHB/ZCL SMK	Surface Mount Kit

Note: See product dimensions section for details.

LENS KIT ACCESSORY ORDERING INFORMATION

Part Number	Order Number	Description
816570	PSHB-LK-CAD-22	PSHB Lens Kit Curved Acrylic Diffuse 2ft-2 Row
816571	PSHB-LK-CAD-24	PSHB Lens Kit Curved Acrylic Diffuse 2ft-4 Row
816572	PSHB-LK-FPD-22	PSHB Lens Kit Flat Polycarbonate Diffuse 2ft-2 Row
816573	PSHB-LK-FPD-24	PSHB Lens Kit Flat Polycarbonate Diffuse 2ft-4 Row
816574	PSHB-LK-FAD-22	PSHB Lens Kit Flat Acrylic Diffuse 2ft-2 Row
816575	PSHB-LK-FAD-24	PSHB Lens Kit Flat Acrylic Diffuse 2ft-4 Row
816576	PSHB-LK-NAC-22	PSHB Lens Kit Narrow Acrylic Clear 2ft-2 Row
816577	PSHB-LK-NAC-24	PSHB Lens Kit Narrow Acrylic Clear 2ft-4 Row

1 Not available with 2ft fixture
 2 LL not available with rotated optics greater than 90 degrees
 3 For a 4 row configuration, only the 2 outside rows are rotated in the factory
 4 For specific EM wattage requirements, please contact factory

5 EM/EMHV not available with ALSC controls options
 6 EM units excluded from Job Packs and individually packaged
 7 The Job Pack (JP) option has a minimum fixture quantity - refer to the pallet quantity table for details

Peak Series High Bay (PSHB) Industrial

Type : _____

 Have questions? Call us at (800) 436-7800

PERFORMANCE

Cord Application Notes							
		Not Dimming				Dimming	
		No Emergency or Controls	Emergency	Controls ¹	Emergency and Controls	No Emergency or Controls	Emergency
Switched Circuitry Using a Wall Switch to Dim ²	Plug	Yes	No	Yes	No	No	No
	# of Cord Wires	3	4	3	4	5	6
Non-Switched Circuitry Using Controls to Dim ³	Plug	Yes	Yes	Yes	Yes	No	No
	# of Cord Wires	3	3	3	3	5	6

Delivered Lumens ⁴											
Size	Lumen Package	Lens Type	Length	CRI	3500K		4000K		5000K		Wattage
					Delivered Lumens	Efficacy	Delivered Lumens	Efficacy	Delivered Lumens	Efficacy	
2FT	12L	LL	2 ft	80	12,191	180	12,145	180	12,391	183	68
	15L	LL	2 ft	80	15,185	179	15,128	179	15,434	182	85
	18L	LL	2 ft	80	18,206	178	18,138	177	18,505	181	102
	24L	LL	2 ft	80	24,227	186	24,136	185	24,625	189	130
	30L	LL	2 ft	80	30,277	183	30,163	183	30,774	186	165
	36L	LL	2 ft	80	35,710	180	35,576	180	36,297	183	198
4FT	48L	LL	4 ft	80	48,783	185	48,600	185	49,584	188	263
	60L	LL	4 ft	80	61,079	182	60,850	182	62,083	185	335
	72L	LL	4 ft	80	71,839	177	71,569	177	73,019	180	405

Lens Lumen Output Scaling	
Lens Type	LL Lumens Multiplied By
FAC	0.97
FAD	0.89
FPC	0.96
FPD	0.85
NAC	0.97
CAC	0.98
CAD	0.91

CRI PRORATION	
80	1.00

CCT PRORATION	
3500	1.004
4000	1.000
5000	1.020

Ambient Temperature Rating		
Lumen Package	Surface Mount	Suspended
12L	45C	60C
15L	45C	55C
18L	45C	55C
24L	45C	55C
30L	45C	55C
36L	45C	55C
48L	45C	55C
60L	45C	55C
72L	40C	50C

Electrical Data - Current Draw AMPS ⁵							
Lumen Package	Wattage	120V	208V	240V	277V	347V	480V
12L	68	0.56	0.33	0.28	0.24	0.19	0.14
15L	85	0.71	0.41	0.35	0.31	0.24	0.18
18L	102	0.85	0.49	0.43	0.37	0.30	0.21
24L	130	1.09	0.63	0.54	0.47	0.38	0.27
30L	165	1.38	0.79	0.69	0.60	0.48	0.34
36L	198	1.65	0.95	0.83	0.72	0.57	0.41
48L	263	2.19	1.27	1.10	0.95	0.76	0.55
60L	335	2.79	1.61	1.40	1.21	0.97	0.70
72L	405	3.38	1.95	1.40	1.46	1.17	0.84

EM Output Lumens ^{6,7}				
Lumen Package	EM Lumens	Wattage ⁸	EMHV	Wattage
12L	2700	15	5400	30
15L	2700	15		
18L	2700	15		
24L	3600	25		
30L	3600	25		
36L	5400	30		
48L	5400	30		
72L	5400	30		

Note: Fixture ambient temperature limited to 30C (86F) when equipped with EM Options.

- External dim leads not available with controls.
- Switched circuitry uses an external switched device to control dimming and requires a second hot to operate the EM.
- Non-switched circuitry uses controls to operate dimming and can be ordered with battery, cord and plug. Battery is fed by the primary incoming hot.
- LED Chips are frequently updated therefore values are nominal.
- Electrical data at 25C (77F). Actual wattage may differ by +/-10%.
- Based on 180 LPW.
- Fixture ambient temperature limited to 30C (86F) when equipped with EM Options.
- EM wattage based on max input watts per manufacturer

Peak Series High Bay (PSHB) Industrial

Type : _____

 Have questions? Call us at (800) 436-7800

PERFORMANCE

Recommended Lumen Maintenance ¹ - PSHB 2 18L					
Ambient Temperature °C	Initial ²	25k hr ²	50k hr ²	75k hr ³	100k hr ³
0	100%	96%	92%	88%	84%
10	100%	96%	92%	88%	84%
20	100%	96%	91%	87%	83%
25	100%	96%	91%	87%	83%
30	100%	95%	91%	86%	82%
40	100%	95%	90%	85%	80%
50	100%	94%	89%	84%	79%
55	100%	94%	88%	83%	78%

Recommended Lumen Maintenance ¹ - PSHB 2 36L					
Ambient Temperature °C	Initial ²	25k hr ²	50k hr ²	75k hr ³	100k hr ³
0	100%	96%	92%	88%	84%
10	100%	96%	92%	88%	84%
20	100%	96%	91%	87%	83%
25	100%	96%	91%	86%	82%
30	100%	95%	90%	86%	82%
40	100%	95%	90%	85%	80%
50	100%	94%	89%	83%	78%

Recommended Lumen Maintenance ¹ - PSHB 4 60L					
Ambient Temperature °C	Initial ²	25k hr ²	50k hr ²	75k hr ³	100k hr ³
0	100%	96%	92%	88%	84%
10	100%	96%	92%	88%	84%
20	100%	96%	92%	88%	84%
25	100%	96%	91%	87%	83%
30	100%	95%	91%	86%	82%
40	100%	95%	90%	85%	81%
50	100%	95%	89%	84%	79%

Recommended Lumen Maintenance ¹ - PSHB 4 72L					
Ambient Temperature °C	Initial ²	25k hr ²	50k hr ²	75k hr ³	100k hr ³
0	100%	96%	92%	87%	84%
10	100%	96%	92%	87%	84%
20	100%	96%	91%	86%	82%
25	100%	95%	90%	86%	81%
30	100%	95%	90%	85%	81%
40	100%	95%	89%	84%	79%
50	100%	94%	88%	83%	77%

1 Lumen maintenance values at 40C are calculated per TM-21 based on LM-80 data and in-situ testing.

2 In accordance with IESNA TM-21-11, Projected Values represent interpolated value based on time durations that are within six times the IESNA LM-80-08 total test duration for the device under testing.

3 In accordance with IESNA TM-21-11, Calculated Values represent time durations that exceed six times the IESNA LM-80-08 total test duration for the device under testing.

Peak Series High Bay (PSHB) Industrial

Type: _____

 Have questions? Call us at (800) 436-7800

PHOTOMETRICS

Luminaire photometry has been conducted by a NVLAP accredited testing laboratory in accordance with IESNA LM-79-08. As specified by IESNA LM-79-08 the entire luminaire is tested as the source resulting in a luminaire efficiency of 100%.

See the individual product page on <https://www.lsicorp.com/> for detailed photometric data.

Optical Distributions for PSHB 2 12L LL (Different Rotations)

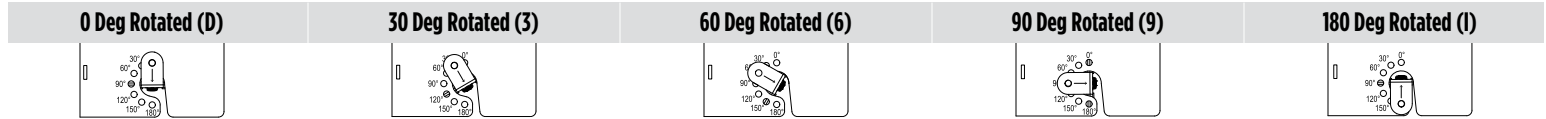

Narrow Acrylic Clear (NAC)

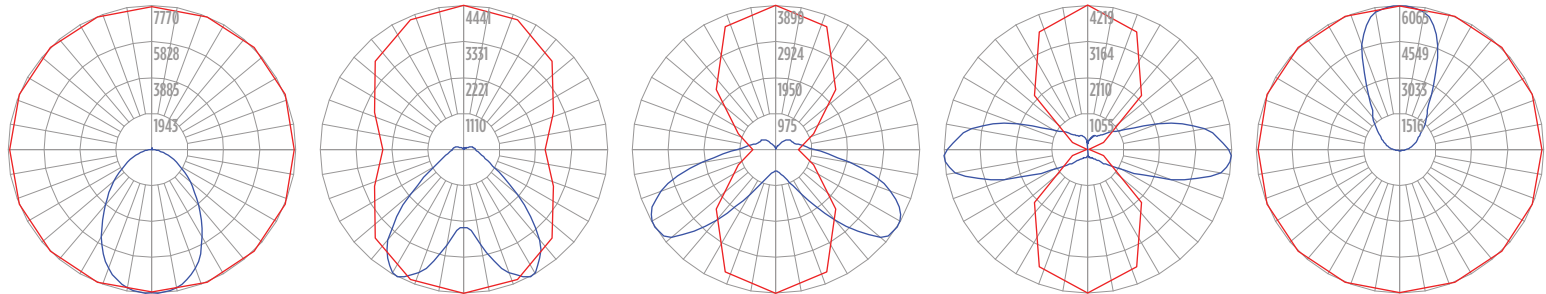

Flat Acrylic Clear (FAC)

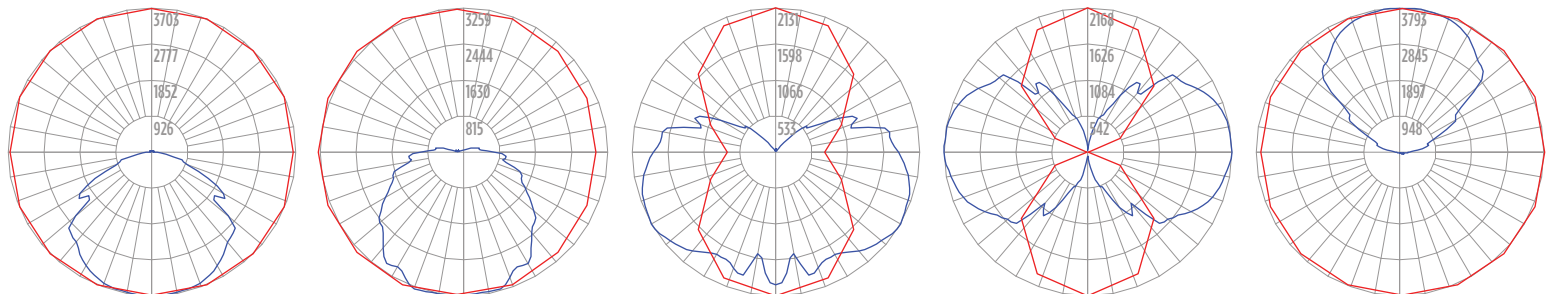

Flat Acrylic Diffuse (FAD)

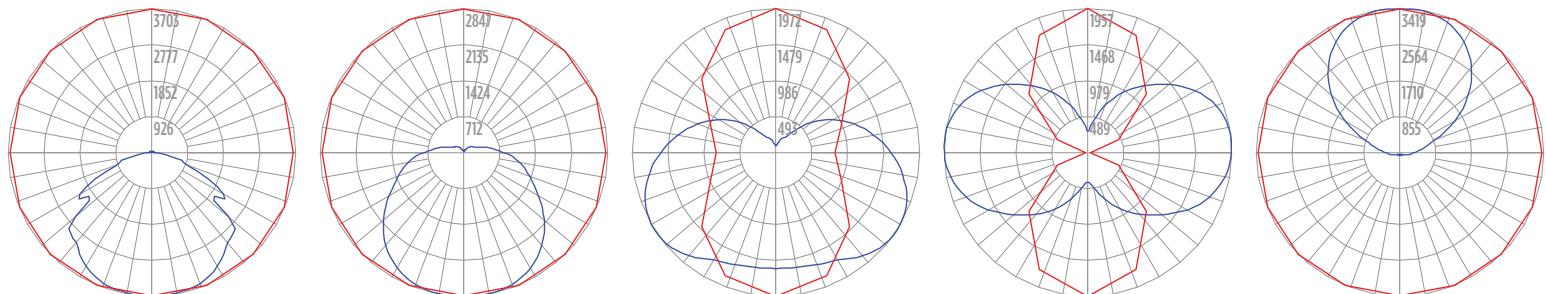

Less Lens (LL)

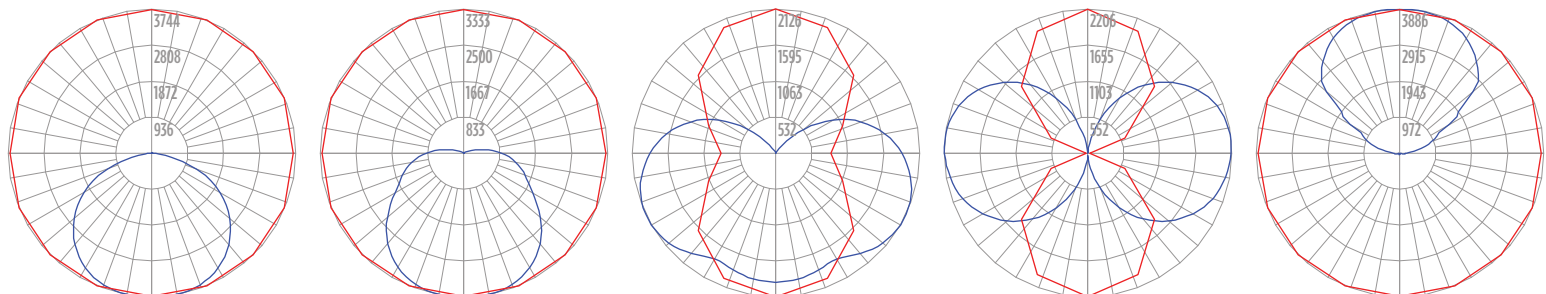

 Vertical Plane  Horizontal Cone

Peak Series High Bay (PSHB) Industrial

Type : _____

Have questions? Call us at (800) 436-7800

PRODUCT DIMENSIONS

Peak Series High Bay, 2 Row
(PSHB 12L-18L)

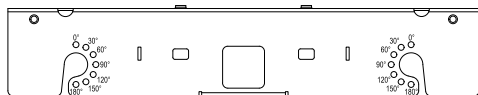

Peak Series High Bay, 4 Row
(PSHB 24L-60L)



0 Degrees - Downlight (Standard)
(D)

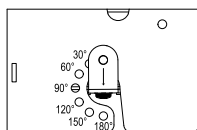

30 Degrees - Wide
(3)

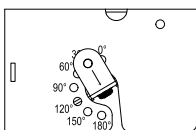

Optical Presets
60 Degrees - Extra Wide
(6)

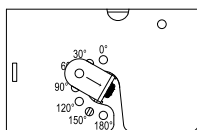

90 Degrees - Side Light
(9)

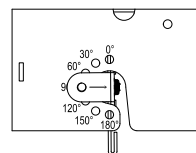

180 Degrees - Indirect (100% Uplight)
(I)

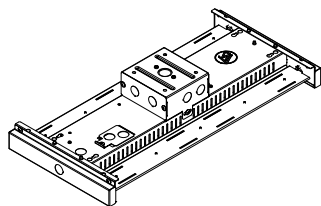
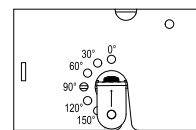

Narrow
(NAC)

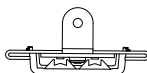

Lens/Distribution
Curved
(CAC, CAD)

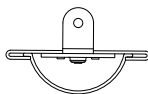

Flat
(FAC, FAD, FPC, FPD)

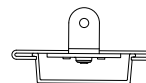

Peak Series High Bay, 2ft, 2 Row with Pendant Mount J-Box Kit
(PSHB 2 12L-18L PMK)

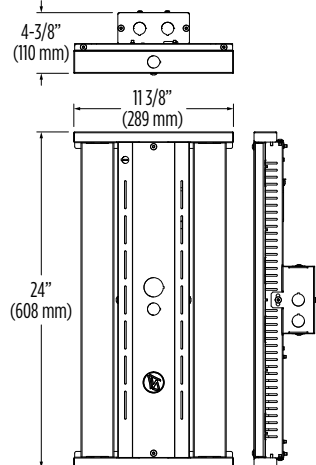

Peak Series High Bay, 2ft, 2 Row
(PSHB 2 12L-18L)

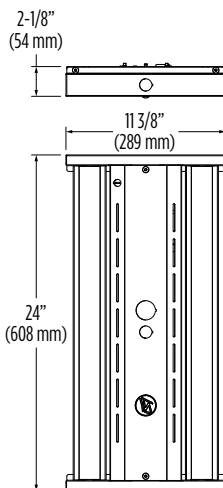

Peak Series High Bay, 2ft, 4 Row
(PSHB 2 24L-36L)

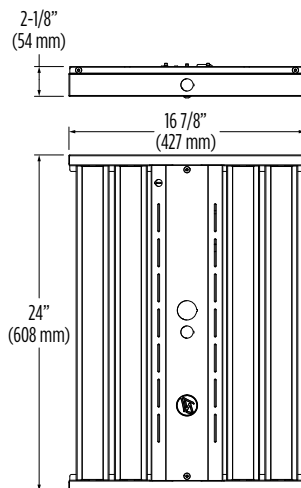

Peak Series High Bay 4ft, 2 Row
(PSHB 4 30L-36L)

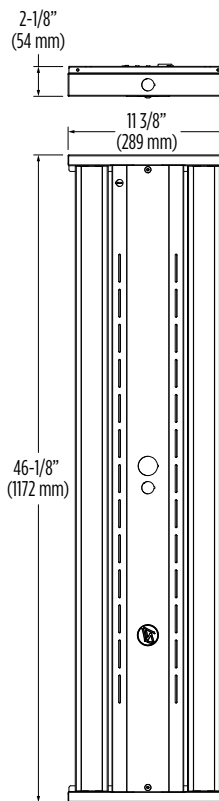

Peak Series High Bay, 4ft, 4 Row
(PSHB 4 48L-72L)

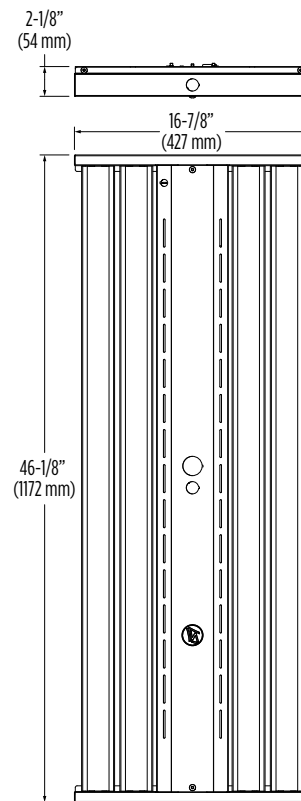

PSHB 12L/15L/18L
1 Pallet Position

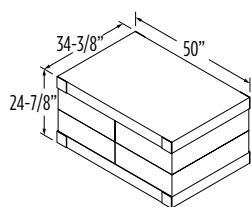

PSHB 24L/30L/36L
1 Pallet Position

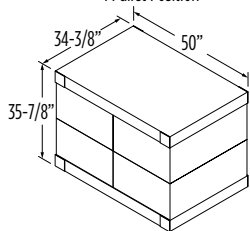

PSHB 48L/60L/72L
1 Pallet Position

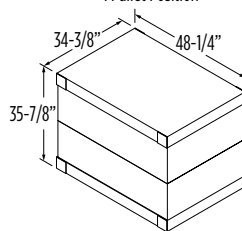

Shipping Weights - lbs (kg)

PSHB 2 12L-18L	9.6 (4.3)
PSHB 2 24L-36L	14.4 (6.5)
PSHB 4 48L-72L	27.8 (12.6)
EM	Add 4.2 (1.9)

Pallet Quantity

Length (ft)	# of Rows	Lumen Package	Individual Box	Job Pack
2	2	12L/15L/18L	36	48 (min. 24 for JP)
2	4	24L/30L/36L	36	48 (min. 24 for JP)
4	2	48L/60L/72L	18	24 (min. 12 for JP)

CONTROLS

Integral Bluetooth™ Motion and Photocell Sensor (IMSBTxL)

Slim low profile sensor provides multi-level control based on motion and/or daylight. Sensor controls 0-10 VDC LED drivers and is IP66 rated for cold and wet locations (-40°F to 167°F). Two unique PIR lenses are available and used based on fixture mounting height. All control parameters are adjustable via an iOS or Android App capable of storing and transmitting sensor profiles.

[Click here to learn more details about IMSBT](#)



LEVITON App



Apple



Android

AirLink Wireless Lighting Controller (ALSC, ALSCS)

The AirLink integrated controller is a California Title 24 compliant lighting controller that provides real-time light monitoring and control with utility-grade power monitoring. It includes a 24V sensor input and power supply to connect a sensor into the outdoor AirLink wireless lighting system. The wireless integrated controller is compatible with this fixture.

[Click here to learn more details about AirLink](#)

AirLink Blue (ALBCSx)

Wireless Bluetooth Mesh Outdoor Lighting Control System that provides energy savings, code compliance and enhanced safety/security for parking lots and parking garages. Three key components; Bluetooth wireless radio/sensor controller, Time Keeper and an iOS App. Capable of grouping multiple fixtures and sensors as well as scheduling time-based events by zone. Radio/Sensor Controller is factory integrated into Area/ Site, Wall Mounted, Parking Garage and Canopy luminaires.

[Click here to learn more details about AirLink Blue](#)



AirLink Blue App



Apple

Sensor Sequence of Operations

Standard Programming	On Event	Off Event	On Light Level	Dim Light Level	Daylight Harvesting	Delay To Off	Sensitivity
OMSBTxL/IMSBTxL	Motion	No Motion	100%	N/A	On; Auto Calibration	20 minutes	High
OMSx	Motion	No Motion	N/A	N/A	N/A	30 seconds	Auto

Operation	Description
On Event	Trigger that activates lights to turn on; either automatic via motion detected or manually activated via push of button.
Off Event	Trigger that activates lights to turn off; either automatic via no motion detected or manually activated via push of button.
On Light Level	The light level that the fixtures will turn on to when ON EVENT occurs.
Dim Light Level	The light level that the fixtures will dim down to when no motion is detected.
Delay to Dim	The amount of time after which no motion is detected that the fixtures will be triggered to dim down. This sequence is optional, and sensor can be programmed to only trigger the fixture to turn off by entering 100% in this field.
Delay to Off	The amount of time after which no motion is detected that the fixtures will be triggered to turn off. If delay to dim is part of the programmed functionality, this is the amount of time after which no motion is detected after the fixture have already dimmed down.
Sensitivity	The sensitivity can be set to high, medium, low, or auto where applicable. High will detect smaller, simple motions. Low will only detect larger more complex motions. Auto temperature calibration adjusts the PIR sensitivity as ambient temperature rises to increase detection of heat movement through the field of view.