



Mirada Medium Wall Sconce (XWM)

Turtle Friendly LED Wall Sconce



OVERVIEW

Lumen Package (lm)	1,000 - 2,000
Wattage Range (W)	15 - 44
Efficacy Range (LPW)	45 - 69
Weight lbs (kg)	27 (12.2)

QUICK LINKS

FEATURES & SPECIFICATIONS

Construction

- Rugged die-cast aluminum housing contains factory prewired driver and optical unit. Hinged die-cast aluminum wiring access door located underneath.
- Galvanized-steel universal wall mount bracket comes standard with hinging mechanism to easily access the junction box wire connections without removing the luminaire.
- Optional pole-mounting bracket (XPGA) permits mounting to standard poles.
- Fixtures are finished with LSI's DuraGrip® polyester powder coat finishing process. The DuraGrip finish withstands extreme weather changes without cracking or peeling. Other standard LSI finishes available. Consult factory.
- Shipping weight: 30 lbs in carton.

Optical System

- State-of-the-Art one piece silicone optic sheet delivers industry leading optical control with an integrated gasket to provide IP65 rated sealed optical chamber in 1 component.
- Proprietary silicone refractor optics provide exceptional coverage and uniformity in Types 2, 3, and Forward Throw (FT) distributions.
- Silicone optical material does not yellow or crack with age and provides a typical light transmittance of 93%.
- Zero uplight.
- Narrow Band amber LEDs.

Electrical

- High-performance programmable driver features over-voltage, under-voltage, short-circuit and over temperature protection. Custom lumen and wattage packages available.
- 0-10V dimming (10% - 100%) standard.
- Standard Universal Voltage (120-277 Vac) Input 50/60 Hz or optional High Voltage (347-480 Vac).
- Operating temperature: -40°C to +40°C (-40°F to +104°F).
- LEDs mounted to metal-core circuit board to maximize heat dissipation
- Components are fully encased in potting material for moisture resistance. Driver complies with FCC standards. Driver and key electronic components can easily be accessed via hinged door.

Controls

- Integral passive infrared Bluetooth™ motion and photocell sensor options. Fixtures operate independently and can be commissioned via an iOS or Android configuration app. Updates and modifications to the control strategy are easily implemented via an intuitive app.
- LSI's AirLink™ Blue lighting control system is a simple feature rich wireless Bluetooth mesh network. The integrated fixture sensor module provides wireless control of grouped fixtures based on motion sensors, daylight or a fully customizable schedule.

Installation

- Universal wall mounting plate easily

mounts directly to 4" octagonal or square junction box.

- 2 fasteners secure the hinged door underneath the housing and provide quick & easy access to the electrical compartment for installing/servicing.
- Optional terminal block accepts up to 12 ga wire.

Warranty

- LSI luminaires carry a 5-year limited warranty. Refer to <https://www.lsicorp.com/resources/terms-conditions-warranty/> for more information.
- 1 Year warranty on Battery Back-up option.

Listings

- Listed to UL 1598 and UL 8750.
- Meets Buy American Act requirements.
- IDA compliant
- Suitable for wet Locations.
- IP65 rated luminaire per IEC 60598.
- 3G rated for ANSI C136.31 high vibration applications when pole mounted (using optional XPGA bracket) or wall mounted.
- IK08 rated luminaire per IEC 66262 mechanical impact code.

Mirada Medium Wall Sconce (XWM)

Type : _____

 **Have questions?** Call us at (800) 436-7800

ORDERING GUIDE

TYPICAL ORDER EXAMPLE: XWM 2 LED 2L AMT UE UE BRZ ALSC					
Prefix	Distribution	LED Technology	Lumen Package	Color Temperature	Voltage
XWM - Mirada Medium Wall Sconce	2 - Type 2 3 - Type 3 FT - Type 4 Forward Throw	LED	1L - 1,000 lms 2L - 2,000 lms Custom Lumen Packages ²	AMT - Narrow Band Amber	UE - Universal Voltage (120-277V) HV - High Voltage (347-480V)
Finish		Controls (Choose One)			Options
BLK - Black BRZ - Dark Bronze GMG - Gun Metal Gray GPT - Graphite MSV - Metallic Silver PLP - Platinum Plus SVG - Satin Verde Green WHT - White		Wireless Controls ALSC - AirLink Synapse Control System ALSCS01 - AirLink Synapse Control System with 8-12' Motion Sensor ALSCS02 - AirLink Synapse Control System with 12-20' Motion Sensor ALBSC1 - AirLink Blue Wireless Motion & Photo Sensor Controller (8-24' mounting height) ALBSC2 - AirLink Blue Wireless Motion & Photo Sensor Controller (25-40' mounting height) Standalone Controls DIM - 0-10v Dimming leads extended to housing exterior IMSBTL1 - Integral Bluetooth™ Motion and Photocell Sensor max 8-24' mounting height ¹ IMSBTL2 - Integral Bluetooth Motion and Photocell Sensor max 25-40' mounting height ¹ Button Type Photocells PCI120 - 120V PCI208 -277 - 208 -277V PCI347 - 347V			XPMA - Pole Mounting Bracket SP1 - 10kV Surge Protection TB - Terminal Block



Need more information?
Click here for our glossary

Have additional questions?
Call us at (800) 436-7800



ACCESSORY ORDERING INFORMATION³

Part Number	Description
356915CLR	XWM Surface Wiring Box
751632	10' Linear Bird Spike Kit (2' Recommended per Luminaire)

¹ IMSBT is field configurable via the LSI app that can be downloaded from your smartphone's native app store.

² Custom lumen and wattage packages available consult factory. Values are within industry standard tolerances but not DLC listed.

³ Accessories are shipped separately and field installed.

Mirada Medium Wall Sconce (XWM)

Type : _____

 Have questions? Call us at (800) 436-7800

PERFORMANCE

DELIVERED LUMENS*					
Lumen Package	Distribution	Narrow Band Amber			Wattage
		Delivered Lumens	Efficacy	BUG Rating	
1L	2	1016	70	B1-U0-G0	15
	3	1040	72	B0-U0-G1	
	FT	1037	72	B0-U0-G1	
2L	2	1964	44	B1-U0-G1	44
	3	2010	45	B1-U0-G1	
	FT	2004	45	B1-U0-G1	

ELECTRICAL DATA (AMPS)*							
Lumens	Wattage	120V	208V	240V	277V	347V	480V
1L	15	0.12	0.07	0.06	0.05	0.04	0.03
2L	44	0.37	0.21	0.18	0.16	0.13	0.09

*Electrical data at 25°C (77°F). Actual wattage may differ by +/-10%

*LEDs are frequently updated therefore values are nominal.

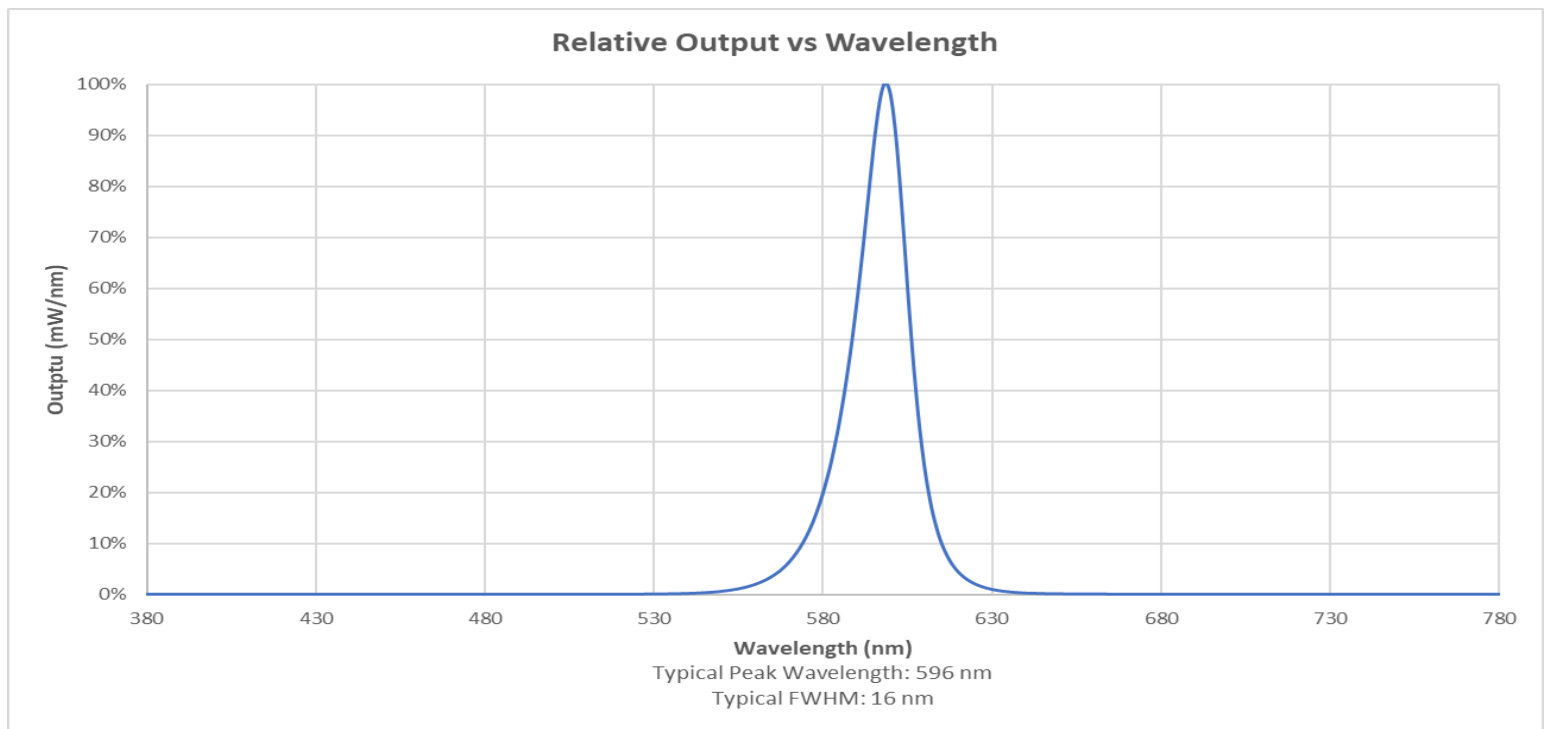

SPECTRAL PERFORMANCE VS LUMEN OUTPUT		
Lumen Package	Peak Wavelength	FWHM
	(nm)	(nm)
1L	593	14
2L	597	18

Mirada Medium Wall Sconce (XWM)

Type: _____

 Have questions? Call us at (800) 436-7800

PRODUCT DIMENSIONS

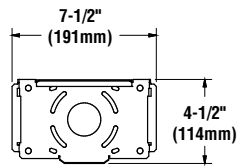
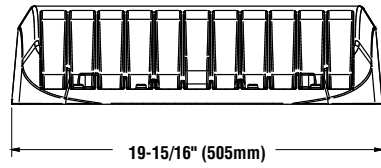
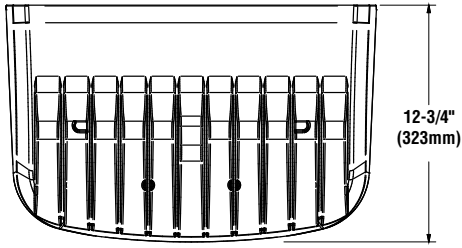

Luminaire Shown with IMSBT

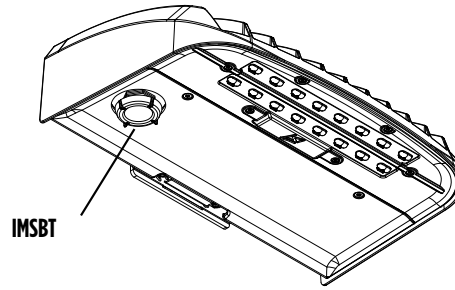

Surface Wiring Box

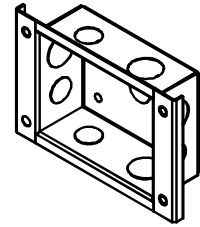

Wet location rated surface wiring box features 1/2" and 3/4" knockouts for surface conduit

Luminaire Shown with PCI

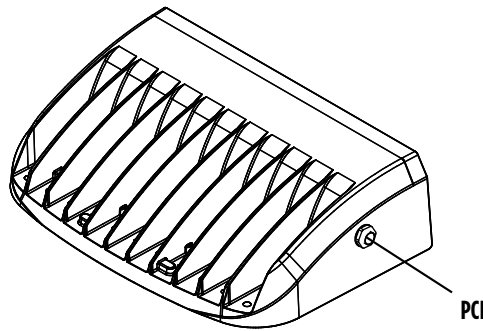

Mirada Medium Wall Sconce (XWM)

Type: _____

 Have questions? Call us at (800) 436-7800

CONTROLS

Integral Bluetooth™ Motion and Photocell Sensor (IMSBTxL)

Slim low profile sensor provides multi-level control based on motion and/or daylight. Sensor controls 0-10 VDC LED drivers and is IP66 rated for cold and wet locations (-40°F to 167°F). Two unique PIR lenses are available and used based on fixture mounting height. All control parameters are adjustable via an iOS or Android App capable of storing and transmitting sensor profiles.

[Click here to learn more details about IMSBT](#)



LEVITON App



Apple



Android

AirLink Blue (ALBCSx)

Wireless Bluetooth Mesh Outdoor Lighting Control System that provides energy savings, code compliance and enhanced safety/security for parking lots and parking garages. Three key components; Bluetooth wireless radio/sensor controller, Time Keeper and an iOS App. Capable of grouping multiple fixtures and sensors as well as scheduling time-based events by zone. Radio/Sensor Controller is factory integrated into Area/ Site, Wall Mounted, Parking Garage and Canopy luminaires.

[Click here to learn more details about AirLink Blue](#)



AirLink Blue App



Apple

Sensor Sequence of Operations

Standard Programming	On Event	Off Event	On Light Level	Dim Light Level	Daylight Harvesting	Delay To Off	Sensitivity
OMSBTxL/IMSBTxL	Motion	No Motion	100%	N/A	On; Auto Calibration	20 minutes	High
OMS	Motion	No Motion	N/A	N/A	N/A	30 seconds	Auto

Operation	Description
On Event	Trigger that activates lights to turn on; either automatic via motion detected or manually activated via push of button.
Off Event	Trigger that activates lights to turn off; either automatic via no motion detected or manually activated via push of button.
On Light Level	The light level that the fixtures will turn on to when ON EVENT occurs.
Dim Light Level	The light level that the fixtures will dim down to when no motion is detected.
Delay to Dim	The amount of time after which no motion is detected that the fixtures will be triggered to dim down. This sequence is optional, and sensor can be programmed to only trigger the fixture to turn off by entering 100% in this field.
Delay to Off	The amount of time after which no motion is detected that the fixtures will be triggered to turn off. If delay to dim is part of the programmed functionality, this is the amount of time after which no motion is detected after the fixture have already dimmed down.
Sensitivity	The sensitivity can be set to high, medium, low, or auto where applicable. High will detect smaller, simple motions. Low will only detect larger more complex motions. Auto temperature calibration adjusts the PIR sensitivity as ambient temperature rises to increase detection of heat movement through the field of view.