



Inground Light (XIG) Legacy

Ingrade Light



OVERVIEW

Lumen Package (lm)	2,000
Wattage Range (W)	19
Efficacy Range (LPW)	110 - 143
Weight lbs (kg)	28 (12.7)

QUICK LINKS

FEATURES & SPECIFICATIONS

Construction

- Composite rough-in housing never corrodes; field-proven to last for more than 20 years without maintenance.
- Luminaire housing is 85% copper alloy for wet locations.
- CNC precision machined housing to insure proper sealing.
- Clear-anodized natural aluminum finish or LSI's DuraGrip® polyester powder coat finishes available. DuraGrip finish withstands extreme weather changes without cracking or peeling, and is guaranteed for a full five years.
- No heat in the LED light beam means a cool lens - no risk of burns to bare feet. Optional slip resistant lens available, to enhance public safety.
- Drive over capability up to 4,000 lbs. of vehicle weight.
- Standard colors include black, white, bronze, metallic silver, graphite and satin verde green. Natural brass matte blast finished.
- Optional 11" diameter x .18" thick stainless steel decorative trim has radial polish finish.
- Luminaire is proudly manufactured in the U.S. of U.S. and imported parts.
- Shipping weight: 28 lbs in carton.

Optical System

- Available with 10°, spot, 25° or 40° flood horizontal beam angle distributions. Optics can be tilted +/- 15° from vertical via external aiming screw, with tamper-resistant spanner tool. Adjustment tool provided.
- 15mm low-iron tempered glass lens does not change color of light emitted. 19mm thick lens supplied with stainless steel trim option to retain flush surface.
- Sealed optical chamber is aimable from outside the unit to ensure integrity of the seal.
- Select high-brightness LEDs in 5000K, 4000K, 3500K, and 3000K color temperature.
- Minimum CRI of 70.

Electrical

- Standard Universal Voltage (120-277 Vac) Input 50/60 Hz.
- Minimum 60,000 hours to 100,000 hours depending upon the ambient temperature of the installation location. See LSI web site for specific guidance.
- State-of-the-art driver technology specifically designed for LSI LED fixtures provides unsurpassed system efficiency.

- Operating temperature: -40°C to +50°C (-40°F to +122°F).
- Surge protection meets ANSI C62.41.2, Scenario 1, Location Category C-low standards (6,000; 3,000A).

Installation

- Rough-in housing can be shipped ahead for pre-casting in concrete.
- Luminaire connects to field wiring via IP-68 rated connector.

Warranty

- LSI luminaires carry a 5-year limited warranty. Refer to <https://www.lsicorp.com/resources/terms-conditions-warranty/> for more information.

Listings

- Meets Buy American Act requirements.
- Suitable for wet locations.

Not recommended for continuously immersed applications

Inground Light (XIG) Legacy Ingrade Light

Type : _____

 **Have questions?** Call us at (800) 436-7800

ORDERING GUIDE

TYPICAL ORDER EXAMPLE: XIG B LED 19 350 NW UNV SP10 BRZ									
Prefix	Housing	Light Source	# of LEDs	Drive Current	Color Temperature	Voltage	Distribution	Finish	Options
XIG - Ingrade Light	B - Brass RIH - Rough in housing	LED	19	350	50 - 5000K 40 - 4000K 35 - 3500K 30 - 3000K	UE - Universal Voltage 120 - 277V	SP10 - 10° Spot NFL25 - 25° Narrow Flood FL40 - 40° Flood	NB - Natural Brass ¹ BLK - Black BRZ - Bronze GMG - Gun Metal Gray GPT - Graphite MSV - Metallic Silver PLP - Platinum Plus SVG - Satin Verde Green WHT - White	SST - Stainless Steel Trim ^{2,3,4} TR - Tamper Resistant DSB - Directional Shield Brass 4 Fasteners RGB - Rock Guard Brass ⁴ SRL - Slip Resistant Lens ⁵



Need more information?
[Click here for our glossary.](#)

Have additional questions?
Call us at (800) 436-7800



ACCESSORY ORDERING INFORMATION⁶

Part Number	Description
G34062	TRKEY - Key for TR Fasteners

PERFORMANCE

Delivered Lumens ⁷											
Lumen Package	Distribution	5000K CCT			4000K CCT			3500K / 3000K CCT			Wattage
		Delivered Lumens	Efficacy	NEMA Type	Delivered Lumens	Efficacy	NEMA Type	Delivered Lumens	Efficacy	NEMA Type	
19 - 350	SP10	2732	143	3 x 3	2623	134	3 x 3	2565	131	3 x 3	19
	NFL25	2290	120	3 x 3	2199	112	3 x 3	2150	110	3 x 3	
	FL40	2487	130	4 x 4	2388	122	4 x 4	2335	119	4 x 4	

- 1 Brass Housing Only
- 2 SST not available with DS or RG options
- 3 Brass housing NOT painted with SST.
- 4 XIG can NOT have DSB, RGB and SST at the same time. Only one.
- 5 SRL is not available with SST option.
- 6 Mounting Options are field installed
- 7 LEDs are frequently updated therefore values are nominal.

Inground Light (XIG) Legacy Ingrade Light

Type: _____

 Have questions? Call us at (800) 436-7800

PRODUCT DIMENSIONS

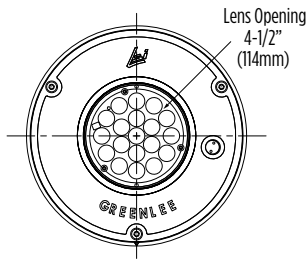

Top View

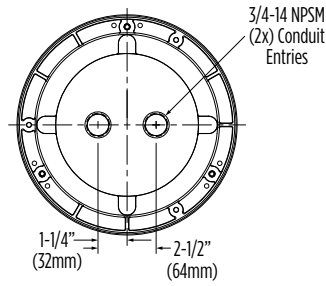

Bottom View

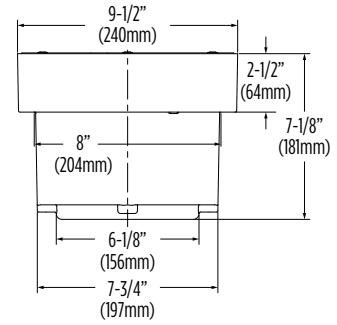

Side View

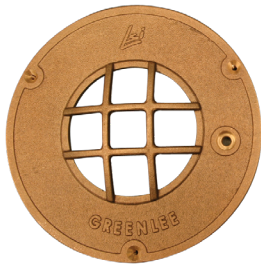

Rock Guard (RGA/B)
Lens/Lamp Protection

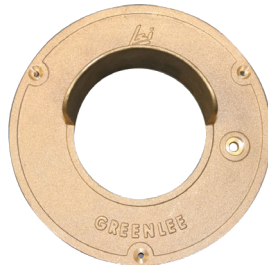

Directional Shield (DSA/B)
Increased Light Control

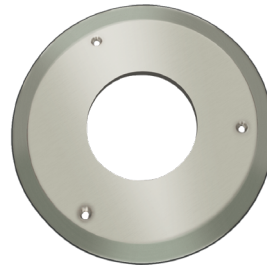

Stainless Steel Trim (SST)
Decorative Appeal

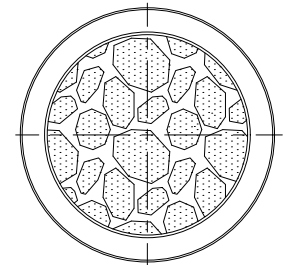

Slip Resistant Lens (SRL)
Enhance Public Safety