

# VERTICAL SURFACE INSTALLATION INSTRUCTION CLRM ARCHITECTURAL LED LUMINAIRE INSTALLATION INSTRUCTION

**⚠ RISK OF FIRE AND ELECTRICAL SHOCK. FIXTURE MUST BE INSTALLED BY A QUALIFIED ELECTRICIAN ONLY IN ACCORDANCE WITH NATIONAL, LOCAL BUILDING AND ELECTRICAL CODES. DISCONNECT POWER AT ELECTRICAL PANEL BEFORE SERVICING.**

## IMPORTANT

1. Read all instructions.
2. Please Install in accordance with national and local electrical code regulations.
3. This product is intended to be installed and serviced by a qualified, licensed electrician.
4. No wet locations! dry and damp locations only!
5. Turn off electrical power before installing or servicing fixture in any way.
6. To reduce the risk of fire and overheating, make sure all connections are tight.
7. Under no circumstances can the lighting fixture be covered with heat insulation gasket or similar materials.

## ACCESSORY



Wire Nut



Anchor

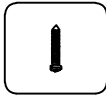

Screw PA4X30



Screw CM4X12



Power Cord

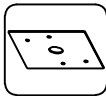

Square Plate

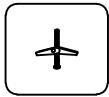

Butterfly Drywall Anchor

## WIRING

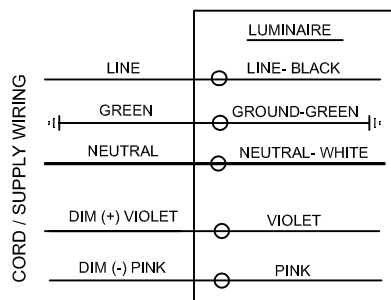

**⚠** Please isolate two dimming wires by P2 terminal individually if no need dimming; MUST connect wires with corresponding colors as shown.

**⚡ SHOCK HAZARD!**  
May result in serious injury or death.  
Turn power OFF at circuit breaker prior to installation or servicing.

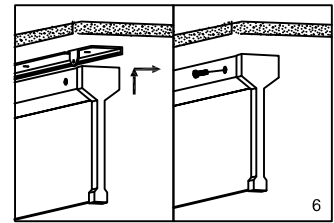
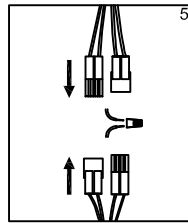
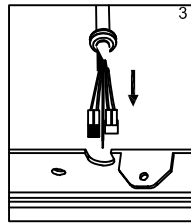
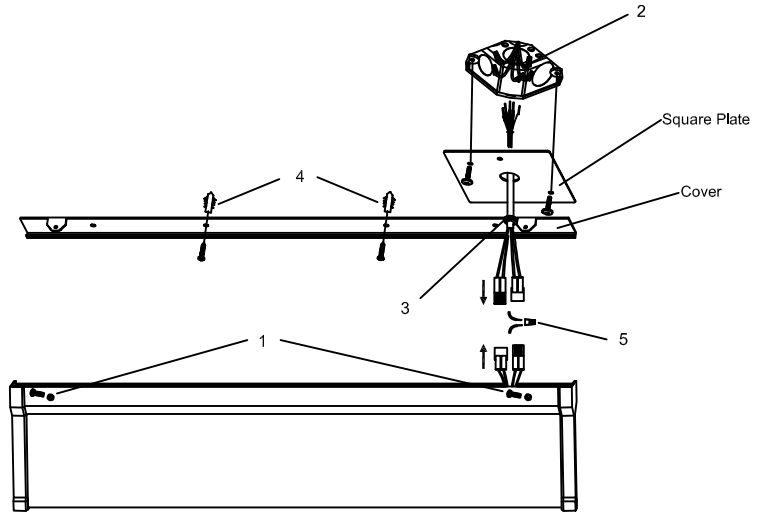

## PLEASE FOLLOW THESE STEPS

- 1 Remove cover via the screws in the side of the housing.
- 2 Connect the wires of power cable (provided) with junction box by the wiring caps.  
Cover the junction box with square plate and fix it with screws, then plaster.
- 3 Insert the power cord into the opening of cover as shown.
- 4 Fix cover to the ceiling.

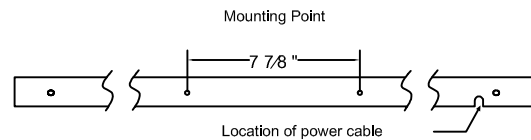
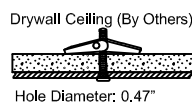
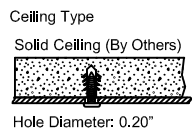

- 5 Connect wires by quick connectors and wiring caps, then hide all wires into the junction box.
- 6 Fix led luminaire on the cover with screws.



# VERTICAL WALL MOUNT INSTALLATION

# CLRM ARCHITECTURAL LED LUMINAIRE INSTALLATION INSTRUCTION

**!** RISK OF FIRE AND ELECTRICAL SHOCK. FIXTURE MUST BE INSTALLED BY A QUALIFIED ELECTRICIAN ONLY IN ACCORDANCE WITH NATIONAL, LOCAL BUILDING AND ELECTRICAL CODES. DISCONNECT POWER AT ELECTRICAL PANEL BEFORE SERVICING.

## IMPORTANT

1. Read all instructions.
2. Install in accordance with national and local electrical code regulations.
3. This product is intended to be installed and serviced by a qualified, licensed electrician.
4. Do not install in wet locations. For dry and damp use only.
5. Turn off electrical power before installing or servicing fixture in any way.
6. To reduce the risk of fire and overheating, make sure all connections are tight.
7. Under no circumstances can the lighting fixture be covered with heat insulation gasket or similar materials.

## ACCESSORY



Wire Nut



Anchor

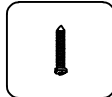

Screw PA4X30

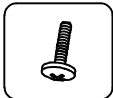

Screw CM4X12



Power Cord

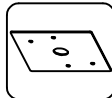

Square Plate

## WIRING

CORD / SUPPLY WIRING		LUMINAIRE	
LINE	○	LINE- BLACK	○
GREEN	○	GROUND-GREEN	○
NEUTRAL	○	NEUTRAL- WHITE	○
DIM (+) VIOLET	○	VIOLET	○
DIM (-) PINK	○	PINK	○

**!** Please isolate two dimming wires by P2 terminal individually if no need dimming; MUST connect wires with corresponding colors as shown.

**⚡** SHOCK HAZARD!  
May result in serious injury or death.  
Turn power OFF at circuit breaker prior to installation or servicing.

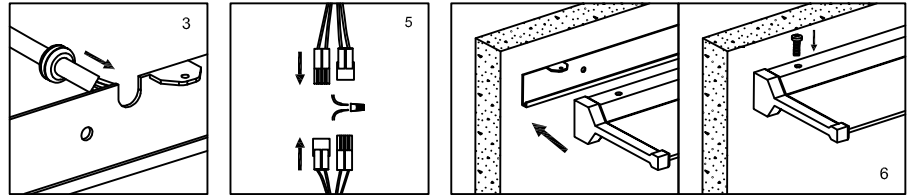
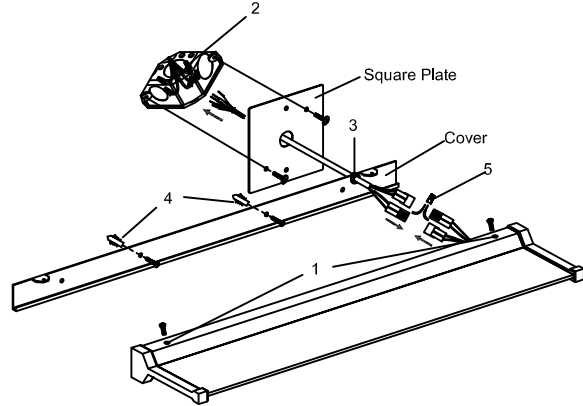

## INSTALLATION STEPS

- 1 Remove cover via the screws in the side of the housing.
- 2 Connect the wires of power cable (provided) with junction box by the wiring caps.  
Cover the junction box with square plate and fix it with screws, then plaster.
- 3 Insert the power cord into the opening of cover as shown.
- 4 Fix cover to the ceiling.

Ceiling Type



Hole Diameter: 0.20"

Mounting Point

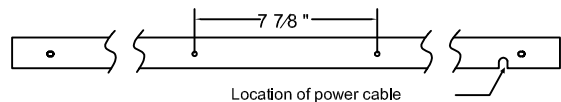

- 5 Connect wires by quick connectors and wiring caps, then hide all wires into the junction box.
- 6 Fix led luminaire on the cover with screws.



# VERTICAL PENDANT INSTALLATION

## CLRM ARCHITECTURAL LED LUMINAIRE INSTALLATION INSTRUCTION

**!** RISK OF FIRE AND ELECTRICAL SHOCK: FIXTURE MUST BE INSTALLED BY A QUALIFIED ELECTRICIAN ONLY IN ACCORDANCE WITH NATIONAL, LOCAL BUILDING AND ELECTRICAL CODES. DISCONNECT POWER AT **!**, ELECTRICAL PANEL BEFORE SERVICING.

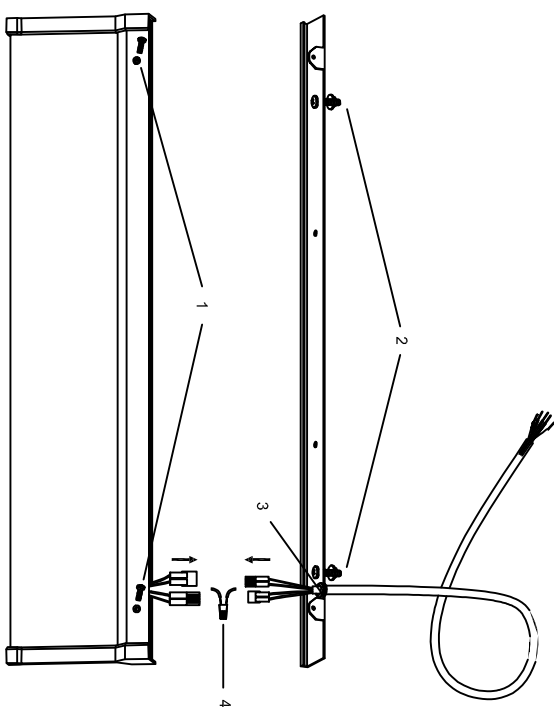
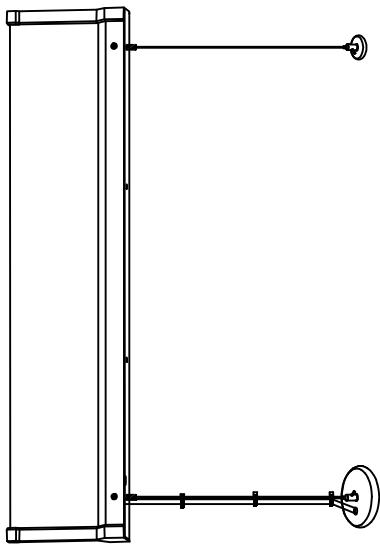

### IMPORTANT

1. Read all instructions.
2. Please install in accordance with national and local electrical code regulations.
3. This product is intended to be installed and serviced by a qualified, licensed electrician.
4. No wet locations; dry and damp locations only!
5. Turn off electrical power before installing or servicing fixture in any way.
6. To reduce the risk of fire and overheating, make sure all connections are tight.
7. Under no circumstances can the lighting fixture be covered with heat insulation gasket or similar materials.

- SHOCK HAZARD!**  
May result in serious injury or death.  
Turn power OFF at circuit breaker prior to installation or servicing.

### WIRING

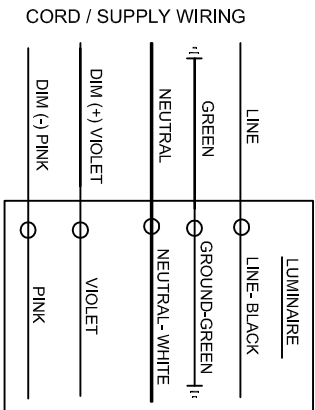

**!** Please isolate two dimming wires by P2 terminal individually if no need dimming. **MUST** connect wires with corresponding colors as shown.

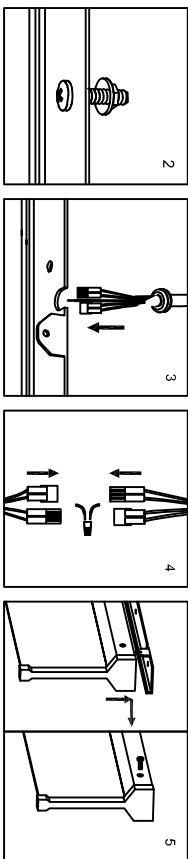

### PLEASE FOLLOW THESE STEPS

1. Remove cover via screws in side of housing.  
(Please noted that there are screws&screwnuts inside the luminaire).
2. Assemble the screws & nuts as shown.
3. Insert the power cord into the opening of cover as shown.
4. Connect wires by quick connects and wiring caps.
5. Reattach the cover by using provided hardware into the led luminaire.
6. Suspend the led luminaire in the ceiling (different ceiling type use corresponding accessory).



# VERTICAL PENDANT INSTALLATION

CLRM ARCHITECTURAL LED LUMINAIRE  
 DRY CEILING INSTALLATION INSTRUCTION

# VERTICAL PENDANT INSTALLATION

ARCHITECTURAL LED LUMINAIRE  
 DROP CEILING INSTALLATION INSTRUCTION

**!** RISK OF FIRE AND ELECTRICAL SHOCK. FIXTURE MUST BE INSTALLED BY A QUALIFIED ELECTRICIAN ONLY IN ACCORDANCE WITH NATIONAL, LOCAL BUILDING AND ELECTRICAL CODES. DISCONNECT POWER AT ELECTRICAL PANEL BEFORE SERVICING.

### ▶ POWER FEED

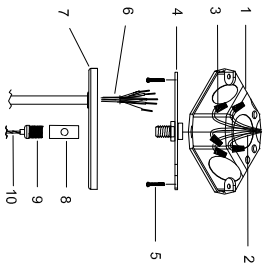



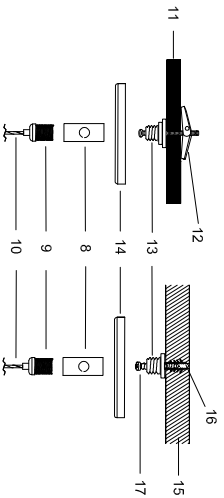

### ▶ NON POWER SUSPENSION



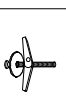

### ▶ PARTS LIST

- 1 4" Octagon Junction Box (By Others)
- 2 Power Cord (By Others)
- 3 Wire Nut
- 4 Junction Box Crossbar
- 5 Screw PM4\*22
- 6 Power Cord
- 7 4" Power Canopy Kit
- 8 Cable Holder
- 9 Strain Relief Thread Nut
- 10 Aircraft Cable
- 11 Drywall Ceiling (By Others)
- 12 Buttery Drywall Anchor
- 13 Clamp Stud
- 14 2" Canopy
- 15 Split Ceiling (By Others)
- 16 Anchor
- 17 Screw PA4\*30







### Canopy

- |   |  |   |
|---|--|---|
|  |                         |  |
| 4 Junction Box Crossbar   | 5 Screw PM4*22   | 7 4" Canopy Power Feed  |
|  |  |   |
| 12 Buttery Drywall Anchor   | 14 2" or 4" Canopy   |   |

### Power Cord

- |   |   |   |
|---|---|---|
|  |  |  |
| 3 Wire Nut  | 6 Power Cord  | 8 Cable Tie   |

### Suspension Kit

- |   |   |   |
|---|---|---|
|  |  |  |
| 8 Cable Holder  | 9 Strain Relief Thread Nut  | 10 Aircraft Cable   |
|  |  |  |
| 13 Clamp Stud   | 16 Anchor   | 17 Screw PA4*30   |

**!** RISK OF FIRE AND ELECTRICAL SHOCK. FIXTURE MUST BE INSTALLED BY A QUALIFIED ELECTRICIAN ONLY IN ACCORDANCE WITH NATIONAL, LOCAL BUILDING AND ELECTRICAL CODES. DISCONNECT POWER AT ELECTRICAL PANEL BEFORE SERVICING.

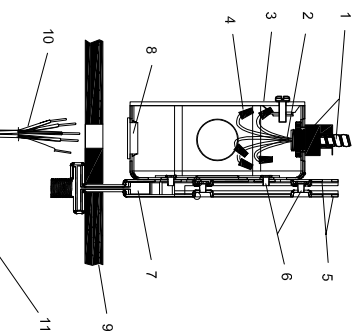

### ▶ POWER FEED



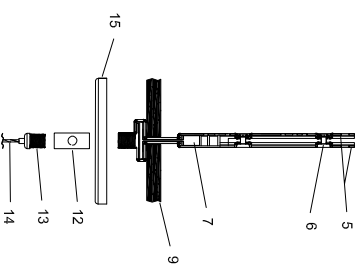

### ▶ NON POWER SUSPENSION



### Junction BOX

- |  |   |
|--|---|
|  |  |
| 3 4" Octagon Junction Box  | 8 Plastic Grommet   |

### T-grid Clips

- |   |   |
|---|---|
|  |  |
| 5 Assembled T-grid Clips  | 6 Screw 6#*4  |

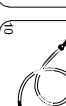
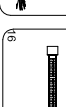

### Power Cord

- |   |   |   |
|---|---|---|
|  |  |  |
| 4 Wire Nut  | 10 Power Cord   | 16 Cable Tie  |

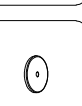
### Canopy

- |   |  |
|---|--|
|  |  |
| 4 4" Canopy Power Feed  | 15 2" or 4" Canopy   |

### Suspension Kit

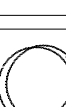
- |   |   |   |
|---|---|---|
|  |  |  |
| 12 Cable Holder   | 13 Strain Relief Thread Nut   | 14 Aircraft Cable   |

### ▶ PARTS LIST

- 1 Armored Cable & Connector (By Others)
- 2 Power Cord (By Others)
- 3 4" Octagon Junction Box
- 4 Wire Nut
- 5 Assembled T-grid Clips
- 6 Screw 6#\*4
- 7 T-grid (By Others)
- 8 Plastic Grommet
- 9 Ceiling Tile (By Others)
- 10 Power Cord
- 11 4" Canopy Power Feed
- 12 Cable Holder
- 13 Strain Relief Thread Nut
- 14 Aircraft Cable
- 15 2" Canopy